

# 2016 TYRE CATALOGUE

## OFF THE ROAD TYRE DATABOOK



[www.zc-rubber.com](http://www.zc-rubber.com)



zc rubber



zc rubber



ZHONGCE RUBBER GROUP CO., LTD.







# CONTENTS

## General Information

05-09

## Off-The-Road Tyres-Radial

13-31

Loader / Earthmover / Grader	13
Cranes	22
Straddle	25
Rigid Dump Truck	27

## Off-The-Road Tyres-Bias

32-72

Loader / Earthmover / Grader	32
Underground	39
Compactor	41
Dump Truck	44
Dessert Application	50
Backhoe	52
Special Machines	57
Skid Steer	59
Port Service	63
Industrial Service-Forklift	68

## Off-The-Road Tyres-Solid

73-82

Resilent	73
Press On	80

## Load & Inflation Pressure Table

83-86

## Radial OTR Range According To Rim

87-88



- A Company established in Year 1958
- No. 1 Tyre Manufacturer in China
- No. 10 of Top 75 Global Tyre Manufacturers in Year 2015
- Sale revenue reached USD4.12 billion in Year 2014

Zhongce Rubber Group Co., Ltd. (ZC-RUBBER) takes great pride in producing tyres that rate among the best in the world. Our corporate philosophy is all about collaboration with our suppliers, with over 10,000s of companies who sell our products around the world, and with our millions of end customers who trust our tyres every single day.

Our engineers are working together closely with our international Research and Development (R&D) team combined of Japanese and Korean experts. We keep on investing millions of US dollars in establishing various production and testing facilities. Meanwhile the quality control system approved by global tyre manufacturers and

international vehicle manufacturers will guarantee the safety and quality of ZC-Rubber tyres.

Today ZC-Rubber is expanding from a Chinese oriented company to a global tyre manufacturer. The subsidiaries located in Southeast Asia, North America, South America and Europe (coming soon) are serving customers without any difference of time and language. The newly established Thailand plant will produce suitable products for local and nearby markets. Safe and value will be the key supplied by ZC-Rubber, who will craft a better future together with partners and friends all over the world.

**Manufacturing Bases**



PCR & LTR Plant in Xiasha    TBR Plant in Xiasha    Rubber Products Plant in Yonggu    Bias Tyre Plant in Xinjiang

**Advanced Production Facility**



Extruding Machine    Germany Fischer Cutting Machine    Germany Krupp Building Machine    Hydraulic Tyre Curing Machine Press

**Strict Quality Inspection**

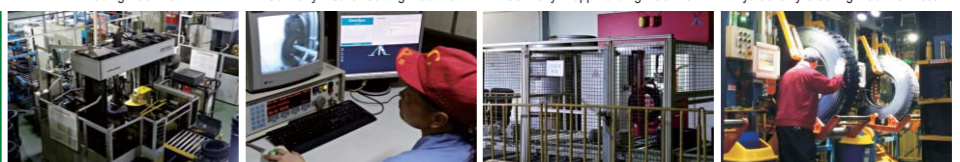

ASTEC Tyre Uniform Testing Machine    Y.MITS Tyre X-ray Inspection Machine    Manual Inspection

**R&D Center**



VMI Tread Waring Test    Noise Analysis Laboratory    Flat-Trac Test System    Bead Unseating Test





# General Information

## Tyre Specification Code

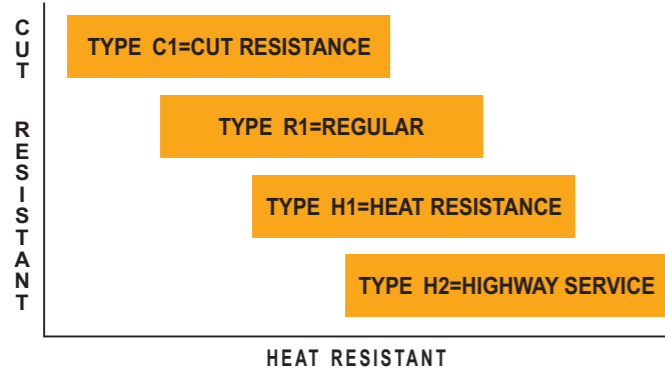

ZC rubber tyre follows the below Tyre Specification Code on it.

	E-Spec./L-spec			Highway
	C1	R1	H1	H2
385/95R24				●
385/95R25				●
445/95R25				●
520/80R25				●
14.00R24	●			
16.00R24	●			
13.00R25	●			
14.00R25	●			
15.5R25	●			
17.5R25	●			
20.5R25	●			
23.5R25	●			
26.5R25	●			
29.5R25	●			
18.00R33	●	●	●	
21.00R35	●	●	●	
24.00R35	●	●	●	
27.00R49	●	●	●	

H1 compound can be available upon request for earthmover application

## Tyre Sidewall Instruction

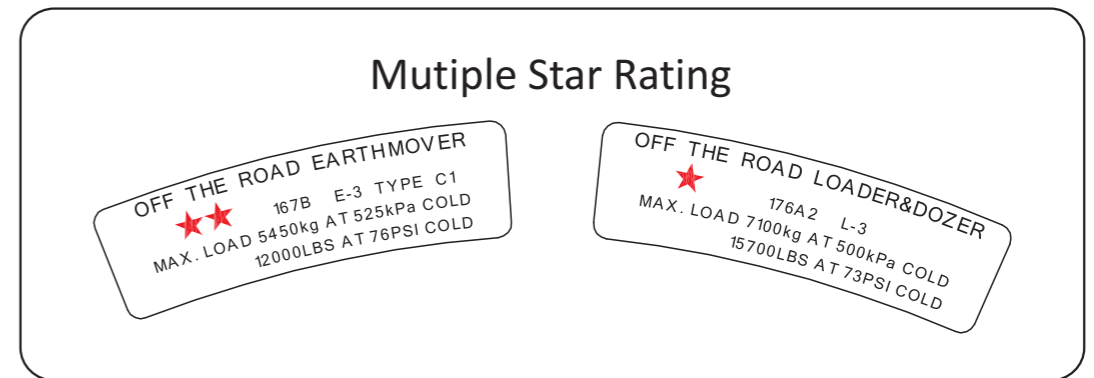
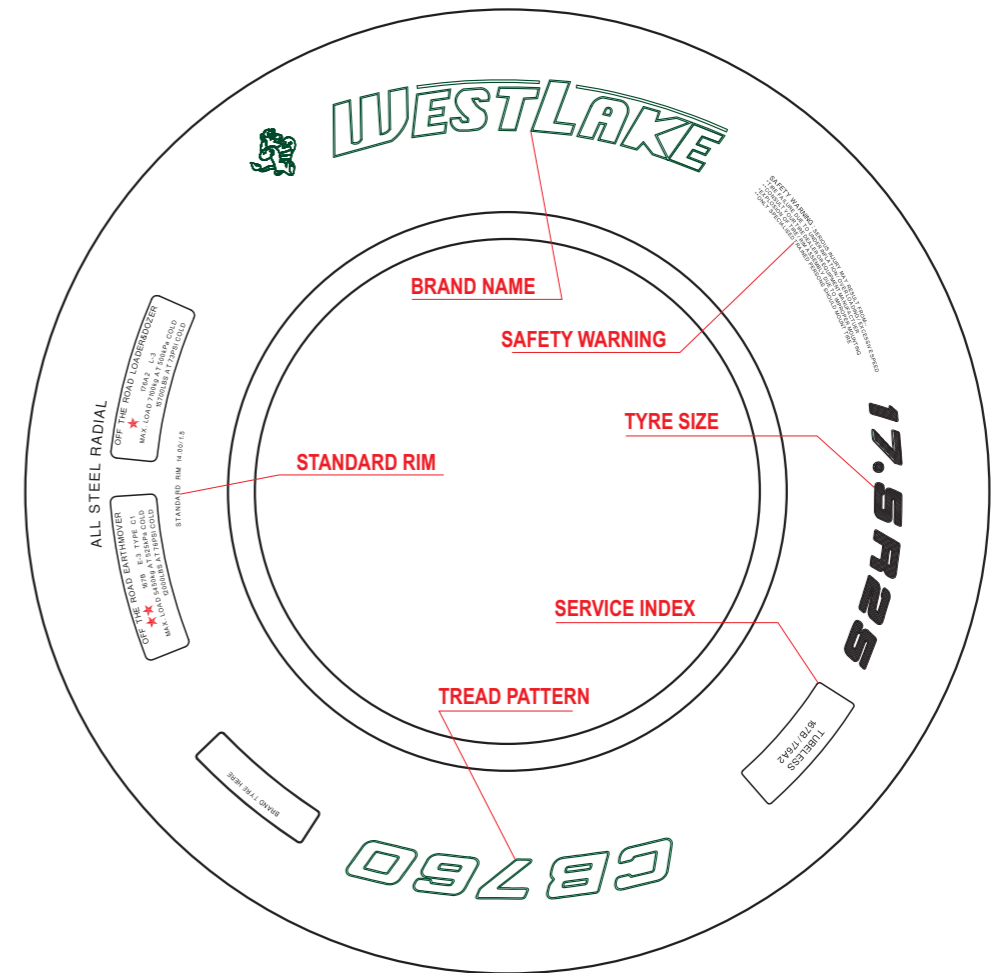

Some of Radial OTR tyres have dual specification codes which can be used for both services, which we call: Multiple Star Rating



# General Information

## Tyre Sidewall Instruction

### Service Classification

ZC rubber tyre has code number on it in order to identify and serve the function.

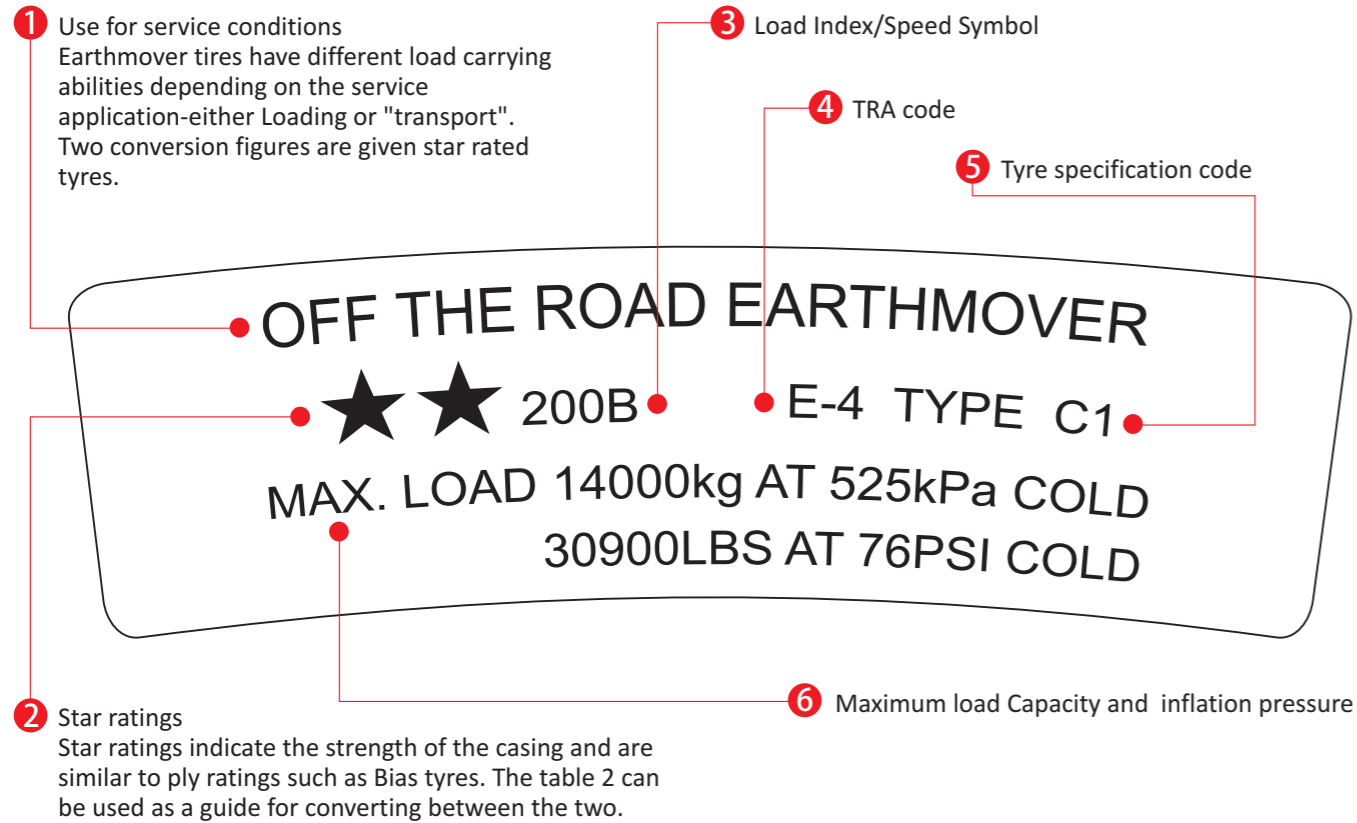

## Conversion table: Star rating to Ply ratings

Loader/Dozer			Earthmover			Grader		
TyreSize	StarMark	PlyRating	TyreSize	StarMark	PlyRating	TyreSize	StarMark	PlyRating
15.5R25	★	UPTO16PR	17.5R25	★★	UPTO16PR	13.00R24	★	UPTO16PR
17.5R25	★	UPTO16PR	20.5R25	★★	UPTO24PR	14.00R24	★	UPTO16PR
20.5R25	★	UPTO24PR	23.5R25	★★	UPTO24PR	16.00R24	★	UPTO16PR
23.5R25	★	UPTO24PR	26.5R25	★★	UPTO24PR			
26.5R25	★	UPTO24PR	29.5R25	★★	UPTO28PR			
29.5R25	★	UPTO28PR	14.00R25	★★	UPTO32PR			
			18.00R33	★★	UPTO40PR			
			21.00R35	★★	UPTO44PR			
			24.00R35	★★	UPTO48PR			
			27.00R49	★★	UPTO54PR			

## Identification of OTR Tyres

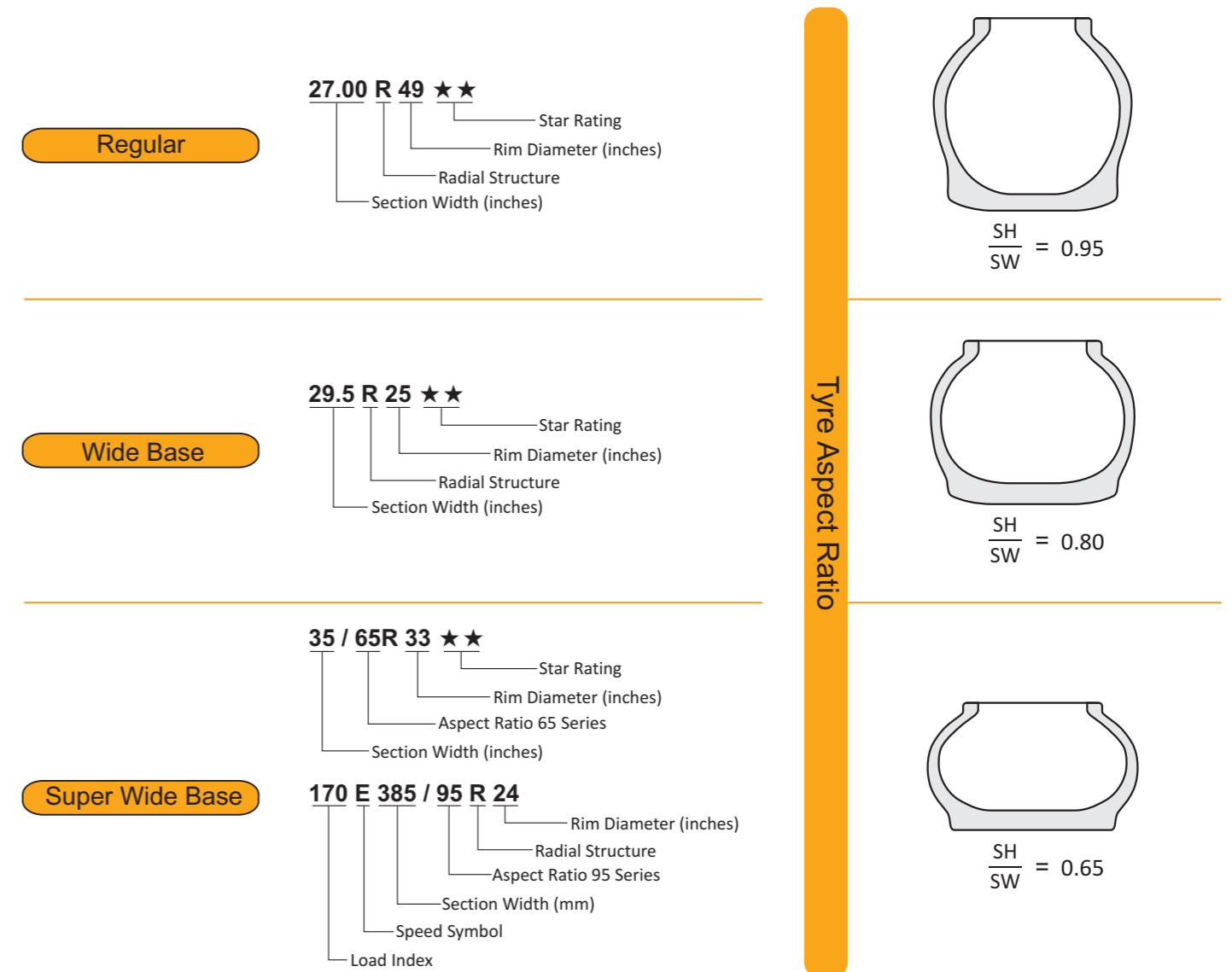

## Comparison of Tread Depth

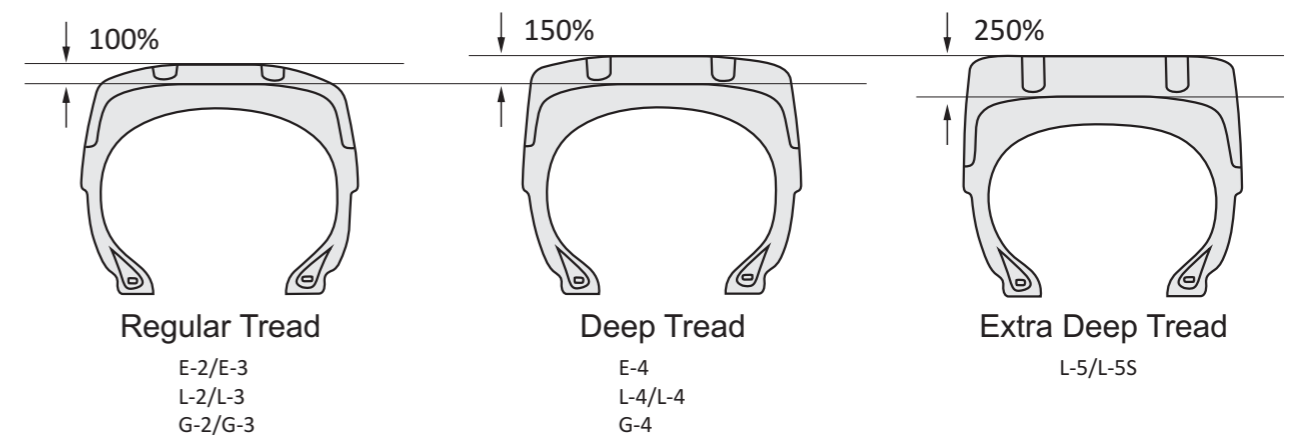



# General Information

## Load Index

The LOAD INDEX is a numerical code with the maximum carrying load capacity.

Load Index	KG	LBS	Load Index	KG	LBS	Load Index	KG	LBS	Load Index	KG	LBS
120	1400	3085	148	3150	6940	176	7100	5700	204	16000	35300
121	1450	3495	149	3250	7160	177	7300	16100	205	16500	36400
122	1500	3305	150	3350	7390	178	7500	16500	206	17000	37500
123	1550	3415	151	3450	7610	179	7750	17100	207	17500	38600
124	1600	3525	152	3550	7830	180	8000	17600	208	18000	39700
125	1650	3640	153	3650	8050	181	8250	18200	209	18500	40800
126	1700	3750	154	3750	8270	182	8500	18700	210	19000	41900
127	1750	3860	155	3875	8540	183	8750	19300	211	19500	43000
128	1800	3970	156	4000	8820	184	9000	19800	212	20000	44100
129	1850	4080	157	4125	9090	185	9250	20400	213	20600	45400
130	1900	4190	158	4250	9370	186	9500	20900	214	21200	46700
131	1950	4300	159	4375	9650	187	9750	21500	215	21800	48100
132	2000	4410	160	4500	9920	188	10000	22000	216	22400	49400
133	2060	4540	161	4625	10200	189	10300	22700	217	23000	50700
134	2120	4675	162	4750	10500	190	10600	23400	218	23600	52000
135	2180	4805	163	4875	10700	191	10900	24000	219	24300	53600
136	2240	4940	164	5000	11000	192	11200	24700	220	25000	55100
137	2300	5070	165	5150	11400	193	11500	25400	221	25750	56800
138	2360	5205	166	5300	11700	194	11800	26000	222	26500	58400
139	2430	5355	167	5450	12000	195	12150	26800	223	27250	60100
140	2500	5510	168	5600	12300	196	12500	27600	224	28000	61700
141	2575	5675	169	5800	12800	197	12850	28300	225	29000	63900
142	2650	5840	170	6000	13200	198	13200	29100	226	30000	66100
143	2725	6005	171	6150	13600	199	13600	30000	227	30750	67800
144	2800	6175	172	6300	13900	200	14000	30900	228	31500	69400
145	2900	6395	173	6500	14300	201	14500	32000	229	32500	71700
146	3000	6610	174	6700	14800	202	15000	33100	230	33500	73900
147	3075	6780	175	6900	15200	203	15500	34200	231	34500	76100

## Speed Symbol

The SPEED SYMBOL indicates the speed at which the tire can carry a load corresponding to its Load Index under service specified conditions.

Speed Symbol	Speed (km/h)	Speed Symbol	Speed (km/h)
A1	5	B	50
A2	10	C	60
A3	15	D	65
A4	20	E	70
A5	25	F	80
A6	30	G	90
A7	35		
A8	40		

## ZC-RUBBER TYRE FEATURES

- Special Tread design for all applications
- Durability of tyres
- Strong tyre casing for retread
- Cool running tires helping to save fuel
- Eco-friendly product and REACH conformity
- ISO 9001 certified production





# Tyre Tread Summary

## Off-The-Road Tyres-Radial



## Off-The-Road Tyres-Bias



## Off-The-Road Tyres-Solid







# OFF-THE-ROAD TYRES-RADIAL

## CB760

Loader / Earthmover / Grader

- ▮ Specially designed non-directional tread pattern offers extra gripping power
- ▮ Longer tread life due to the deeper tread depth and unique tread compound
- ▮ New sidewalls are shaped to minimize damage from cutting
- ▮ Optimised Retreading Ability because of the robust casing



Size	TRA Code	Ply Rating	Service Index	Standard Rim	Tread Depth (mm)	Tread Depth (32HD)	TT/TL
17.5R25	E3/L3	★★	167B 176A2	14.00/1.5	27.0	34	TL
20.5R25	E3/L3	★★	177B 186A2	17.00/2.0	28.5	36	TL
23.5R25	E3/L3	★★	185B 195A2	19.50/2.5	35.5	45	TL

\* Multiple Star Rating



# OFF-THE-ROAD TYRES-RADIAL Loader / Earthmover / Grader

With its unique technology, ZC Rubber Group develops full range of Loader Earthmover Grader Tyres, 60 years experience of tyre design and production offer us great advantage in understanding the rubber, the steel, the carbon black and customer demand

The range of ZC Rubber Group tyres provides you with an one stop solution adapted to your work





# OFF-THE-ROAD TYRES-RADIAL



## CB761

Loader / Earthmover / Grader

- Classical design with high resistance to impacts and cuts
- Longer tread life due to the deeper tread depth
- New sidewall design for enhanced reinforcement and protection
- Optimised Retreading because of the robust casing

Size	TRA Code	Ply Rating	Service Index	Standard Rim	Tread Depth (mm)	Tread Depth (32ND)	TT/TL
15.5R25	L3	★	169A2	12.00/1.3	26.0	33	TL <b>NEW</b>
20.5R25	E3/L3	★★	177B 186A2	17.00/2.0	33.0	42	TL <b>NEW</b>
23.5R25	E3/L3	★★	185B 195A2	19.50/2.5	36.0	45	TL <b>NEW</b>
26.5R25	E3/L3	★★	193B 202A2	22.00/3.0	37.0	47	TL
29.5R25	E3/L3	★★	200B 208A2	25.00/3.5	43.0	54	TL <b>NEW</b>

\* Multiple Star Rating



# OFF-THE-ROAD TYRES-RADIAL



## CB792

Loader / Earthmover / Grader

- Latest design with alternating and multi-edged blocks offers better flotation and excellent traction on soft and muddy soil
- Longer tread life due to the deeper tread depth and unique tread compound
- Additional protective sidewalls are shaped to minimize damage from cutting
- Optimised Retreading Ability because of the robust casing

Size	TRA Code	Ply Rating	Service Index	Standard Rim	Tread Depth (mm)	Tread Depth (32ND)	TT/TL
23.5R25	E3+/L3+	★★	185B 195A2	19.50/2.5	38.0	48	TL
26.5R25	E3+/L3+	★★	193B 202A2	22.00/3.0	40.0	50	TL
29.5R25	E3+/L3+	★★	200B 208A2	25.00/3.5	44.0	55	TL

\* Multiple Star Rating





# OFF-THE-ROAD TYRES-RADIAL



## CB763

Loader / Earthmover / Grader

- Latest design with alternating and multi-edged blocks offers better flotation and super traction on soft and muddy soil
- Longer tread life due to the deeper E4/L4 tread depth and unique tread compound
- Additional protective sidewalls are shaped to minimize damage from cutting
- Optimised Retreading Ability because of the robust casing

Size	TRA Code	Ply Rating	Service Index	Standard Rim	Tread Depth (mm)	Tread Depth (32ND)	TT/TL
29.5R25	E4/L4	★★	200B 208A2	25.00/3.5	59.0	74	TL
23.5R25	E4/L4	★★	185B 195A2	19.50/2.5	53.0	67	TL <b>NEW</b>
26.5R25	E4/L4	★★	193B 202A2	22.00/3.0	56.0	71	TL <b>NEW</b>

\* Multiple Star Rating



# OFF-THE-ROAD TYRES-RADIAL



## CB768

Loader / Earthmover / Grader

- Extra large block pattern provides both abrasion resistance and excellent traction on all kinds of surfaces
- Longer tread life due to the deeper tread depth and unique tread compound
- Additional protective sidewalls are shaped to minimize damage from cutting
- Optimised Retreading Ability because of the robust casing

Size	TRA Code	Ply Rating	Service Index	Standard Rim	Tread Depth (mm)	Tread Depth (32ND)	TT/TL
23.5R25	E-3/L-3	★★	185B 201A2	19.50/2.5	44.0	55	TL
29.5R25	E-4/L-4	★★	200B 208A2	25.00/3.5	50.0	63	TL

\* Multiple Star Rating





# OFF-THE-ROAD TYRES-RADIAL



## CB773

Loader / Earthmover / Grader

- Super deep tread pattern designed for wheel loader, dozer and grader requiring maximum traction
- Perfect lug face ensures equal load distribution and even contact area
- Additional protective sidewalls are shaped to minimize damage from cutting
- Optimised Retreading Ability because of the robust casing

Size	TRA Code	Ply Rating	Service Index	Standard Rim	Tread Depth (mm)	Tread Depth (32ND)	TT/TL
23.5R25	L-5	★★	201A2	19.50/2.5	76.0	96	TL
26.5R25	L-5	★★	209A2	22.00/3.0	86.0	108	TL
29.5R25	L-5	★★	216A2	25.00/3.5	94.0	118	TL



# OFF-THE-ROAD TYRES-RADIAL



## CB790

Loader / Earthmover / Grader

- Super deep open tread pattern designed for wheel loader, dozer and grader requiring maximum traction
- Substantial crown and robust shoulders reinforced with a protection band make up a tyre
- Additional protective sidewalls are shaped to minimize damage from cutting
- Optimised Retreading Ability because of the robust casing

Size	TRA Code	Ply Rating	Service Index	Standard Rim	Tread Depth (mm)	Tread Depth (32ND)	TT/TL
20.5R25	L5	★★	193A2	17.00/2.0	72.0	91	TL
23.5R25	L-5	★★	201A2	19.50/2.5	78.0	98	TL
26.5R25	L-5	★★	209A2	22.00/3.0	88.0	111	TL
29.5R25	L-5	★★	216A2	25.00/3.5	96.0	121	TL





# OFF-THE-ROAD TYRES-RADIAL



**NEW**

## CB776

Loader / Earthmover / Grader

- Unique non-directional pattern design contributes to efficient fuel consumption and guarantees operating comfort
- Great traction and flotation on soft and muddy surfaces

Size	TRA Code	Ply Rating	Service Index	Standard Rim	Tread Depth (mm)	Tread Depth (32ND)	TT/TL
14.00R24	G-2/L-2	★	153A8	8.00TG	26.0	33	TL
13.00R24	G-2/L-2	★	146A8	8.00TG	25.0	31	TL
16.00R24	G-2/L-2	★	161A8	10.00VA	29.0	37	TL



## OFF-THE-ROAD TYRES-RADIAL Cranes

The cranes has very high speed and heavy load in both highway and rough terrain, which requests a robust but light tyre. ZC Rubber Group cranes tyres is one of the few brands has both the ECE and DOT certificate for all highway crane tyre



# OFF-THE-ROAD TYRES-RADIAL

# OFF-THE-ROAD TYRES-RADIAL



## CM770

### Cranes

- Unique irregular wear pattern guarantees greater operator comfort, and lower rolling resistance performance
- Special crane compound help offer shorter braking distance and longer tyre life
- DOT/ECE Certificated

Size	Ply Rating	Service Index	Standard Rim	Tread Depth (mm)	Tread Depth (32ND)	TT/TL
395/85R20(14.00R20)	20PR	170F	10.00	17.5	22	TL <small>NEW</small>
385/95R24(14.00R24)	★★★	170F	10.00/1.5	24.0	30	TT <small>NEW</small>
385/95R25(14.00R25)	★★★	170F	10.00/1.5	24.0	30	TL
445/95R25(16.00R25)	★★★	174F 177E	11.25/2.0	28.0	35	TL



## CM767

### Cranes

- Long-lasting non-directional pattern design contributes to efficient fuel consumption and guarantees operating comfort
- Special crane compound help offer shorter braking distance and longer tyre life
- DOT/ECE Certificated

Size	Ply Rating	Service Index	Standard Rim	Tread Depth (mm)	Tread Depth (32ND)	TT/TL
525/80R25(20.5R25)	★★★	176F 179E	17.00/2.0	28.5	36	TL







# OFF-THE-ROAD TYRES-RADIAL Straddle

More than 8 years experience in more than 65 ports gives me very deep understanding of how port works, what they need, what is the tread in port straddle

CR766 and CR766+ is absolute idea choice of all port users



## OFF-THE-ROAD TYRES-RADIAL



# CR766

## Straddle

- Robust rib patterns help to increase dynamic stability and driving comfort during traveling
- Extended longer tyre life due to the sophisticated tread design.
- OEM Certificated

### CR766

Size	TRA Code	Ply Rating	Service Index	Standard Rim	Tread Depth (mm)	Tread Depth (32ND)	TT/TL
16.00R25	STRADDLE	★★	200A5	11.25/2.0	50.0	63	TL

### CR766+

Size	TRA Code	Ply Rating	Service Index	Standard Rim	Tread Depth (mm)	Tread Depth (32ND)	TT/TL
16.00R25	STRADDLE	★★	202A7	11.25/2.0	50.0	63	TL <sup>(NEW)</sup>







## OFF-THE-ROAD TYRES-RADIAL

## OFF-THE-ROAD TYRES-RADIAL Rigid Dump Truck

The rigid dump trucks are primarily used in mines and large construction sites. Safety, Zero Harm, High Efficiency and Low Hour Cost is always the mines operation's priority concern. ZC Rubber developed a full range of rigid dump truck tyres up to 100 tones, Powerful Japanese RD teams designed massive tyre compounds for different compounds, no matter in cold and hot, coal and iron ore, you can find the suitable ZC products for your machine



## CB765

### Rigid Dump Truck

- Rock flush pattern provide excellent defense again impacts and cuts
- Unique compounds generate longer tyre life and fewer punctures
- Four steel belts offer greater strength and durability
- Optimised Retreading Ability because of the robust casing

Size	TRA Code	Ply Rating	Service Index	Standard Rim	Tread Depth (mm)	Tread Depth (32ND)	TT/TL
14.00R24	E-3	★★★	169B	10.00/1.5	27.0	34	TT
13.00R25	E-3	★★★	163B	10.00/1.5	27.0	34	TT
14.00R25	E-3	★★★	169B	10.00/1.5	27.0	34	TT
24.00R35	E-4	★★	209B	17.00/3.5	57.0	72	TL







# CB771

## Rigid Dump Truck

- Aggressive lug design with large blocks at tread centre provides excellent traction and braking on rough road
- Different compounds to optimize performance in all applications
- Additional protective sidewalls are shaped to minimize damage from cutting
- Optimised Retreading Ability because of the robust casing

Size	TRA Code	Ply Rating	Service Index	Standard Rim	Tread Depth (mm)	Tread Depth (32ND)	TT/TL
14.00R25	E-4	★★★	169B	10.00/1.5	38.0	48	TT/TL
18.00R33	E-4	★★	191B	13.00/2.5	54.0	68	TL
24.00R35	E-4	★★	209B	17.00/3.5	65.0	82	TL



**NEW**

# CB775

## Rigid Dump Truck

- A revolutionary design with independent tread pattern blocks guarantee excellent traction and longer tyre life in tough road application
- Different compounds to optimize performance in all applications
- Additional protective sidewalls are shaped to minimize damage from cutting
- Optimised Retreading Ability because of the robust casing

Size	TRA Code	Ply Rating	Service Index	Standard Rim	Tread Depth (mm)	Tread Depth (32ND)	TT/TL
27.00R49	E-4	★★	223B	19.50/4.0	63.0	79	TL





# OFF-THE-ROAD TYRES-RADIAL



**NEW**

## CB791

### Rigid Dump Truck

- Aggressive lug design with extra deep grooves offer strong traction for dump trucks requiring power traction to travel over soft and muddy terrain
- Different compounds to optimize performance in all applications
- Additional protective sidewalls are shaped to minimize damage from cutting
- Optimised Retreading Ability because of the robust casing

Size	TRA Code	Ply Rating	Service Index	Standard Rim	Tread Depth (mm)	Tread Depth (32ND)	TT/TL
27.00R49	E-4	★★	223B	19.50/4.0	72.0	91	TL



# OFF-THE-ROAD TYRES-BIAS Loader / Earthmover / Grader



# OFF-THE-ROAD TYRES-BIAS

# OFF-THE-ROAD TYRES-BIAS



Classic no-directional tread design formulated with Cut resistance compound  
Together with a robust duty nylon carcass makes it capable of withstanding cuts, chip in all tough service conditions

## CL728

Loader / Earthmover / Grader

Size	TRA Code	Ply Rating	Standard Rim	Tread Depth (mm)	Overall Diameter (mm)	Section Width (mm)	Max. Load Capacity (KG)	Cold Inflation Pressure (KPA)	TT/TL
23.5-25	E-3	16	19.50/2.5	33.0	1615	595	6150	225	TT/TL
	L-3	16	19.50/2.5	33.0	1615	595	9500	300	TT/TL
	E-3	20	19.50/2.5	33.0	1615	595	7300	300	TT/TL
	L-3	20	19.50/2.5	33.0	1615	595	10900	375	TT/TL
	E-3	24	19.50/2.5	33.0	1615	595	8000	350	TT/TL
	L-3	24	19.50/2.5	33.0	1615	595	12500	475	TT/TL
29.5-25	E-3	28	25.00/3.5	50.0	1875	750	11500	325	TL
	L-3	28	25.00/3.5	50.0	1875	750	17500	425	TL
	L-3	34	25.00/3.5	50.0	1875	750	20000	525	TL



Classic no-directional tread design formulated with Cut resistance compound  
Together with a robust duty nylon carcass makes it capable of withstanding cuts, chip in all tough service conditions

## E3/L3

Loader / Earthmover / Grader

Size	TRA Code	Ply Rating	Standard Rim	Tread Depth (mm)	Overall Diameter (mm)	Section Width (mm)	Max. Load Capacity (KG)	Cold Inflation Pressure (KPA)	TT/TL
16.00-25	E-3	28	11.25/2.0	29.0	1495	430	6700	575	TT/TL
	L-3	28	11.25/2.0	29.0	1495	430	11500	750	TT/TL
	E-3	32	11.25/2.0	29.0	1495	430	7300	650	TT/TL
	L-3	32	11.25/2.0	29.0	1495	430	16875	1000	TT/TL
26.5-25	E-3	20	22.00/3.0	39.0	1750	675	8250	250	TL
	L-3	20	22.00/3.0	39.0	1750	675	13200	350	TL
	E-3	28	22.00/3.0	39.0	1750	675	10000	350	TL
	L-3	28	22.00/3.0	39.0	1750	675	15500	475	TL



Classic no-directional tread design formulated with Cut resistance compound  
Together with a robust duty nylon carcass makes it capable of withstanding cuts, chip in all tough service conditions

## CL729

Loader / Earthmover / Grader

Size	TRA Code	Ply Rating	Standard Rim	Tread Depth (mm)	Overall Diameter (mm)	Section Width (mm)	Max. Load Capacity (KG)	Cold Inflation Pressure (KPA)	TT/TL
17.5-25	E-3	12	14.00/1.5	26.0	1350	445	3650	225	TT/TL
	L-3	12	14.00/1.5	26.0	1350	445	6150	350	TT/TL
	E-3	16	14.00/1.5	26.0	1350	445	4250	300	TT/TL
	L-3	16	14.00/1.5	26.0	1350	445	7300	470	TT/TL
20.5-25	E-3	16	17.00/2.0	31.0	1495	520	5450	275	TT/TL
	L-3	16	17.00/2.0	31.0	1495	520	8250	350	TT/TL
	E-3	20	17.00/2.0	31.0	1495	520	6000	325	TT/TL
	L-3	20	17.00/2.0	31.0	1495	520	9500	450	TT/TL



Extra deep tread depth offers the tyres much longer life with lower cost per hour  
Cut resistance compound suitable for loader and haulage operation under all tough conditions

## CL629

Loader / Earthmover / Grader

Size	TRA Code	Ply Rating	Standard Rim	Tread Depth (mm)	Overall Diameter (mm)	Section Width (mm)	Max. Load Capacity (KG)	Cold Inflation Pressure (KPA)	TT/TL
26.5-25	E-3+	28	22.00/3.0	42	1750	675	10000	350	TL
	E-3+	32	22.00/3.0	42	1750	675	11200	425	TL
	L-3+	28	22.00/3.0	42	1750	675	15500	475	TL
	L-3+	32	22.00/3.0	42	1750	675	17000	550	TL
	L-3+	36	22.00/3.0	42	1750	675	24200	750	TL



**NEW**



**26.5-25**

Extra deep non directional sturdy lug pattern provides good traction for rugged mining, quarrying  
 Rubust casing with unique cut resistance compound provides longer life

**23.5-25**

Classic no-directional tread design formulated with Cut resistance compound  
 Rubust casing with unique cut resistance compound provides longer life

**35/65-33**

Special designed for big loaders with tough working condition  
 Unique cut resistance tread compound and tough carcass prevents cuts and impact damage

**EL27**

Loader / Earthmover / Grader

Size	TRA Code	Ply Rating	Standard Rim	Tread Depth (mm)	Overall Diameter (mm)	Section Width (mm)	Max. Load Capacity (KG)	Cold Inflation Pressure (KPA)	TT/TL
26.5-25	E-4	28	22.00/3.0	54	1780	675	15500	475	TL
	L-4	28	22.00/3.0	54	1780	675	10000	350	TL
23.5-25	E-3	20	19.5/2.5	35	1615	595	10900	375	TL
	L-3	20	19.5/2.5	35	1615	595	7300	300	TL
35/65-33	L-5	36	28.00/3.5	100	2075	890	23600	525	TL

**NEW**



Extra deep non directional sturdy lug pattern provides good traction for rugged mining quarrying

Unique cut resistance tread compound and tough carcass prevents cuts and impact damage

**EL29**

Loader / Earthmover / Grader

Size	TRA Code	Ply Rating	Standard Rim	Tread Depth (mm)	Overall Diameter (mm)	Section Width (mm)	Max. Load Capacity (KG)	Cold Inflation Pressure (KPA)	TT/TL
29.5-25	L-4	28	25.00/3.5	57	1970	830	11500	325	TL
	E-4	28	25.00/3.5	57	1970	830	17500	425	TL
	L-4	34	25.00/3.5	57	1970	830	13000	400	TL
	E-4	34	25.00/3.5	57	1970	830	20000	525	TL

**NEW**



New economic tyre for low intensity application

**EL36**

Loader / Earthmover / Grader

Size	TRA Code	Ply Rating	Standard Rim	Tread Depth (mm)	Overall Diameter (mm)	Section Width (mm)	Max. Load Capacity (KG)	Cold Inflation Pressure (KPA)	TT/TL
17.5-25	E-3	12	14.00/1.5	23.0	1350	445	3650	225	TT
	L-3	12	14.00/1.5	23.0	1350	445	6150	350	TT
23.5-25	E-3	16	19.50/2.5	33.0	1615	595	6150	225	TT
	L-3	16	19.50/2.5	33.0	1615	595	9500	300	TT



# OFF-THE-ROAD TYRES-BIAS

# OFF-THE-ROAD TYRES-BIAS



## CB716

Loader / Earthmover / Grader

Size	TRA Code	Ply Rating	Standard Rim	Tread Depth (mm)	Overall Diameter (mm)	Section Width (mm)	Max. Load Capacity (KG)	Cold Inflation Pressure (KPA)	TT/TL
15.5-25	G2/L2	12	12.00/1.3	24.5	1275	395	5600	400	TT
15.5-25	G2/L2	16	12.00/1.3	24.5	1275	395	6750	550	TT
13.00-24	G2/L2	12	10.0	24.5	1300	350	5600	450	TT
17.5-25	G-2	12	14.00/1.5	26.0	1350	445	3650	225	TT/TL
	L-2	12	14.00/1.5	26.0	1350	445	6150	350	TT/TL
	G-2	16	14.00/1.5	26.0	1350	445	4250	300	TT/TL
	L-2	16	14.00/1.5	26.0	1350	445	7300	475	TT/TL



## E3/L3

Loader / Earthmover / Grader

Size	TRA Code	Ply Rating	Standard Rim	Tread Depth (mm)	Overall Diameter (mm)	Section Width (mm)	Max. Load Capacity (KG)	Cold Inflation Pressure (KPA)	TT/TL
14.00-24	E3/L3	16	10.0	25.5	1370	375	7300	550	TT/TL
14.00-24	E3/L3	24	10.0	25.5	1370	375	9500	850	TT/TL
14.00-24	E3/L3	28	10.0	25.5	1370	375	10000	925	TT
15.5-25	E3/L3	12	12.00/1.3	24.5	1275	395	5600	400	TT/TL
15.5-25	E3/L3	16	12.00/1.3	24.5	1275	395	6750	550	TT



## G2/L2

Loader / Earthmover / Grader

Size	TRA Code	Ply Rating	Standard Rim	Tread Depth (mm)	Overall Diameter (mm)	Section Width (mm)	Max. Load Capacity (KG)	Cold Inflation Pressure (KPA)	TT/TL
13.00-24TG	G2/L2	12	8.00TG	25.5	1280	335	5600	450	TT/TL
13.00-24TG	G2/L2	16	8.00TG	25.5	1280	335	6500	600	TT/TL
14.00-24TG	G2/L2	12	8.00TG	25.5	1350	360	6300	425	TT/TL
14.00-24TG	G2/L2	16	8.00TG	25.5	1350	360	7300	550	TT/TL





## OFF-THE-ROAD TYRES-BIAS

## OFF-THE-ROAD TYRES-BIAS Underground



**NEW**

Extra deep slick pattern is designed for tough underground conditions  
Unique compound ensures maximum resistance to cutting, tearing and wearing

### SM05

Underground

Size	TRA Code	Ply Rating	Standard Rim	Tread Depth (mm)	Overall Diameter (mm)	Section Width (mm)	Max. Load Capacity (KG)	Cold Inflation Pressure (KPA)	TT/TL
10.00-20	L-5S	14	7.5	40.0	1055	278	4695	690	TT
12.00-24	L-5S	20	8.5	50.0	1275	315	6900	825	TT
14.00-24	L-5S	28	10	65.0	1370	375	14100	1000	TT
18.00-25	L-5S	32	13.00/2.5	90.0	1675	500	15000	750	TL



Extra deep slick pattern is designed for tough underground conditions  
Unique compound ensures maximum resistance to cutting, tearing and wearing

### SM03

Underground

Size	TRA Code	Ply Rating	Standard Rim	Tread Depth (mm)	Overall Diameter (mm)	Section Width (mm)	Max. Load Capacity (KG)	Cold Inflation Pressure (KPA)	TT/TL
12.00-24	L-4S	20	8.5	35.0	1275	315	6900	825	
10.00-20	L-4S	14	7.5	31.0	1055	278	4695	690	TT





# OFF-THE-ROAD TYRES-BIAS

## OFF-THE-ROAD TYRES-BIAS Compactor



### C-7 Compactor

Size	TRA Code	Ply Rating	Standard Rim	Tread Depth (mm)	Overall Diameter (mm)	Section Width (mm)	Max. Load Capacity (KG)	Cold Inflation Pressure (KPA)	TT/TL
23.1-26	C-7	8	DW20	17.0	1500	595	4000	140	TT/TL
	C-7	12	DW20	17.0	1500	595	5150(10km/h)	200	TT/TL



### CS730 Compactor

Size	TRA Code	Ply Rating	Standard Rim	Tread Depth (mm)	Overall Diameter (mm)	Section Width (mm)	Max. Load Capacity (KG)	Cold Inflation Pressure (KPA)	TT/TL
14.00-24	L-4S	20	10.0	45	1360	360	8500	700	TT



# OFF-THE-ROAD TYRES-BIAS



## CS726

Compactor

Size	TRA Code	Ply Rating	Standard Rim	Tread Depth (mm)	Overall Diameter (mm)	Section Width (mm)	Max. Load Capacity (KG)	Cold Inflation Pressure (KPA)	TT/TL
11.00-20	C-1	16	8.0	22.5	1080	290	5430	725	TT
11.00-20	C-1	24	8.0	22.5	1080	290	7075	1125	TT
13/80-20	C-1	16	8.5	22.0	1060	319	5430	800	TT



# OFF-THE-ROAD TYRES-BIAS Dump Truck





# CL735

Dump Truck

Size	TRA Code	Ply Rating	Standard Rim	Tread Depth (mm)	Overall Diameter (mm)	Section Width (mm)	Max. Load Capacity (KG)	Cold Inflation Pressure (KPA)	TT/TL
10.00-20	E-3	18	7.5	26.0	1073	278	5445	890	TT
11.00-20	E-3	20	8.0	30.0	1105	293	5535	900	TT
12.00-20	E-3	20	8.5	30.0	1145	315	6335	900	TT
12.00-24	E-3+	24	8.5	30	1275	315	7500	975	TT
13.00-25	E-3	28	8.5	32	1300	350	9380	1050	TT
	E-3	36	8.5	32	1300	350	10625	1300	TT
14.00-24	E-3+	24	10.0	32	1370	375	8400	850	TT
	E-3+	28	10.0	32	1370	375	10000	925	TT
14.00-25	E-3+	28	12.00/2.0	32	1370	375	10000	925	TT
	E-3+	36	12.00/2.0	32	1370	375	11645	1200	TT
	E-3+	28	12.00/2.0	32	1370	375	10000	925	TL
18.00-25	E-3	32	13.00/25	38.0	1615	495	8750	575	TT/TL
	L-3	32	13.00/25	38.0	1615	495	15000	750	TT/TL
	E-3	36	13.00/25	38.0	1615	495	9250	625	TT/TL
L-3	36	13.00/25	38.0	1615	495	16000	850	TT/TL	



# CL736

Dump Truck

Size	TRA Code	Ply Rating	Standard Rim	Tread Depth (mm)	Overall Diameter (mm)	Section Width (mm)	Max. Load Capacity (KG)	Cold Inflation Pressure (KPA)	TT/TL
14.00-20	E-3	24	10.00	23.0	1265	375	8400	850	TT
13.00-25	E-3	28	8.5	26	1300	350	9380	1050	TT
	E-3	36	8.5	26	1300	350	10625	1300	TT
14.00-24	E-3	24	10.0	26	1370	375	8400	850	TT
	E-3	28	10.0	26	1370	375	10000	925	TT
14.00-25	E-3	28	12.00/2.0	26	1370	375	10000	925	TT
	E-3	36	12.00/2.0	26	1370	375	11645	1200	TT
11.00-20	E-3	20	8.0	27	1105	293	5535	900	TT
12.00-20	E-3	20	8.5	27	1145	315	6335	900	TT



# EL35

Dump Truck

Size	TRA Code	Ply Rating	Standard Rim	Tread Depth (mm)	Overall Diameter (mm)	Section Width (mm)	Max. Load Capacity (KG)	Cold Inflation Pressure (KPA)	TT/TL
16.00-25	E-3	32	11.25/2.0	38	1495	430	7300	650	TT
18.00-25	E-4	32	13.00/2.5	55	1675	500	8750	575	TT/TL
	E-4	36	13.00/2.5	55	1675	500	9250	625	TT/TL
18.00-33	E-4	32	13.00/2.5	52	1875	500	10000	575	TL
21.00-33	E-3	32	15.00/3.0	46	1940	570	10300	500	TL
21.00-35	E-4	36	15.00/3.0	51	2005	570	12850	550	TL
	E-4	40	15.00/3.0	51	2005	570	14000	625	TL
24.00-35	E-4	42	17.00/3.5	55	2175	655	16500	550	TL





# CL739

Dump Truck

Size	TRA Code	Ply Rating	Standard Rim	Tread Depth (mm)	Overall Diameter (mm)	Section Width (mm)	Max. Load Capacity (KG)	Cold Inflation Pressure (KPA)	TT/TL
11.00-20	E-3	20	8.0	27.0	1105	293	5535	900	TT
12.00-20	E-3	20	8.5	27.0	1145	315	6335	900	TT
12.00-24	E-3	24	8.5	26	1275	315	7500	975	TT



# CL711

Dump Truck

Size	TRA Code	Ply Rating	Standard Rim	Tread Depth (mm)	Overall Diameter (mm)	Section Width (mm)	Max. Load Capacity (KG)	Cold Inflation Pressure (KPA)	TT/TL
12.00-24	20	160/156G	8.5	35	1247	315	4500	880	TT



# CL710

Dump Truck

Size	TRA Code	Ply Rating	Standard Rim	Tread Depth (mm)	Overall Diameter (mm)	Section Width (mm)	Max. Load Capacity (KG)	Cold Inflation Pressure (KPA)	TT/TL
11.00-20	20	-	8.0	33.0	1105	293	5535	900	TT
12.00-20	20	-	8.5	33.0	1145	315	6335	900	TT
12.00-24	20	160/156G	8.5	35	1247	315	4500	880	TT



# L9066

Dump Truck

Size	TRA Code	Ply Rating	Standard Rim	Tread Depth (mm)	Overall Diameter (mm)	Section Width (mm)	Max. Load Capacity (KG)	Cold Inflation Pressure (KPA)	TT/TL
12.00-24	20+	160/156G	8.5	30	1247	315	4500	880	TT



# OFF-THE-ROAD TYRES-BIAS



## CL969

Dump Truck

Size	LR/PR	Standard Rim	Tread Depth (mm)	Overall Diameter (mm)	Section Width (mm)	Max. Load (KG)		Cold Inflation (KPA)		TT/TL
						Single	Dual	Single	Dual	
12.00-24	J/18	8.5	23.0	1225	315	4250	3750	810	740	TT
	L/20	8.5	23.0	1225	315	4500	4000	880	810	TT
12.00-20	J/18	8.5	23.0	1125	315	3750	3350	810	740	TT
	L/20	8.5	23.0	1125	315	4000	3450	880	810	TT



# OFF-THE-ROAD TYRES-BIAS Desert Application



# OFF-THE-ROAD TYRES-BIAS



## ES01

Dessert Application

Size	Ply Rating	Standard Rim	Tread Depth (mm)	Overall Diameter (mm)	Section Width (mm)	10KM/H		50KM/H	
						Max. Load Capacity (KG)	Cold Inflation Pressure(KPA)	Max. Load Capacity (KG)	Cold Inflation Pressure(KPA)
29.5-25	28	25.00/3.5	22.5	1830	750	-	-	10000	240



## ES02

Dessert Application

Size	Ply Rating	Standard Rim	Tread Depth (mm)	Overall Diameter (mm)	Section Width (mm)	Max. Load Capacity (KG)	Cold Inflation Pressure (KPA)	MAX SPEED
9.00-16	8	7JJ	9.5	890	255	1400	310	30KM/H
	6	7JJ	9.5	890	255	1215	250	30KM/H
9.00-17	8	71/2J	9.5	910	255	1450	310	30KM/H



# OFF-THE-ROAD TYRES-BIAS Backhoe





# EL23

Backhoe

Size	TRA Code	Ply Rating	Standard Rim	Tread Depth (mm)	Overall Diameter (mm)	Section Width (mm)	Max. Load Capacity (KG)	Cold Inflation Pressure (KPA)	TT/TL
18.4-26	R-4	12	Dw16	30	1425	467	4000	250	TL
16.9-28	R-4	12	W15L	31	1410	430	3550	260	TL

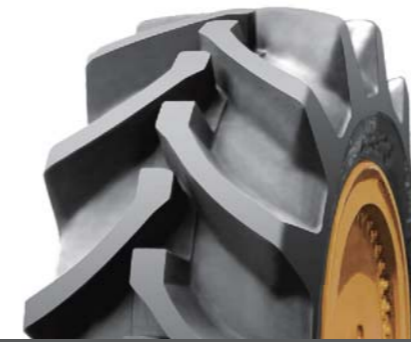

# CB526

Backhoe

Size	TRA Code	Ply Rating	Standard Rim	Tread Depth (mm)	Overall Diameter (mm)	Section Width (mm)	Max. Load Capacity (KG)	Cold Inflation Pressure (KPA)	TT/TL
19.5L-24	R-4	12	Dw16	27	1340	495	2145	210	TT



# EL53

Backhoe

Size	TRA Code	Ply Rating	Standard Rim	Tread Depth (mm)	Overall Diameter (mm)	Section Width (mm)	Max. Load Capacity (KG)	Cold Inflation Pressure (KPA)	TT/TL
12.5/80-18	R-4	12	9	26	985	308	2625	370	TL
	R-4	14	9	26	985	308	2910	430	TL
10.5/80-18	R-4	12	9	26	905	274	1350	370	TL
16.9-24	R-4	12	W15L	34	1310	429	3250	260	TL



# EL28

Backhoe

Size	TRA Code	Ply Rating	Standard Rim	Tread Depth (mm)	Overall Diameter (mm)	Section Width (mm)	Max. Load Capacity (KG)	Cold Inflation Pressure (KPA)	TT/TL
16/70-16	L-2	12	10.00F	17.5	940	380	1990	325	TT
20.5/70-16	L-2	14	13SDC	17.2	1070	480	2290	325	TT
7.50-16	L-2	12	6.00G	14	805	215	1030	375	TT
8.25-16	L-2	14	6.50H	13	855	235	1240	425	TT
9.00-16	L-2	14	6.50H	14	890	255	1340	425	TT
11.00-16	L-2	14	7.00N	15	980	285	1655	375	TT
12.00-16	L-2	14	7.00N	15.5	1020	300	1810	375	TT





# R-4

Backhoe

Size	TRA Code	Ply Rating	Standard Rim	Tread Depth (mm)	Overall Diameter (mm)	Section Width (mm)	Max. Load Capacity (KG)	Cold Inflation Pressure (KPA)	TT/TL
19.5L-24	R-4	12	DW16A	27.0	1314	485	3450	230	TL
	R-4	14	DW16A	27.0	1314	485	3750	260	TL
21L-24	R-4	12	DW18A	27.5	1378	533	3875	220	TL



NEW

# EL56

Backhoe

Size	TRA Code	Ply Rating	Standard Rim	Tread Depth (mm)	Overall Diameter (mm)	Section Width (mm)	Load Capacity at various speed(KG)		TT/TL
							10KM/H	50KM/H	
16/70-20	E3/L3	14	13SDC	18	1075	410	5100(450kPa)	2900(350kPa)	TT



# CB715

Backhoe

Size	TRA Code	Ply Rating	Standard Rim	Tread Depth (mm)	Overall Diameter (mm)	Section Width (mm)	Load Capacity at various speed(KG)		TT/TL
							10KM/H	50KM/H	
16/70-24	E3/L3	14	13SDC	22.5	1175	410	5600(450kPa)	3350(350kPa)	TT
16/70-20	E3/L3	14	13SDC	22.5	1075	410	5100(450kPa)	2900(350kPa)	TT



NEW

# EL55

Backhoe

Size	Ply Rating	Standard Rim	Tread Depth (mm)	Overall Diameter (mm)	Section Width (mm)	Load Capacity at various speed(KG)				Cold Inflation Pressure (KPA)	TT/TL
						10KM/H	25KM/H	40KM/H	50KM/H		
9.00-20	14	7	20.0	1038	259	4385	3230	2885	2770	760	TT





## OFF-THE-ROAD TYRES-BIAS

## OFF-THE-ROAD TYRES-BIAS Special Machines



**NEW**

## M9088

Special Machines

Size	LR/PR	Standard Rim	Tread Depth (mm)	Overall Diameter (mm)	Section Width (mm)	Max. Load (KG)		Cold Inflation (KPA)		TT/TL
						Single	Dual	Single	Dual	
10.00-20	J/18	7.0	21.6	1073	278	3350	2900	910	840	TT
11.00-20	J/18	8.0	22.0	1105	293	3650	3150	910	840	TT
12.00-20	L/20	8.5	22.0	1125	315	4000	3450	880	810	TT
14.00-20	L/20	10.0	21.0	1240	375	5000	4375	770	700	TT



## CL908

Special Machines

Size	LR/PR	Standard Rim	Tread Depth (mm)	Overall Diameter (mm)	Section Width (mm)	Max. Load (KG)		Cold Inflation (KPA)		TT/TL
						Single	Dual	Single	Dual	
14.00-20	L/20	10.0	20.0	1240	375	5000	4375	770	700	TT





## OFF-THE-ROAD TYRES-BIAS

## OFF-THE-ROAD TYRES-BIAS Skid Steer



### CL718

Skid Steer

Size	TRA Code	Ply Rating	Standard Rim	Tread Depth (mm)	Overall Diameter (mm)	Section Width (mm)	Max. Load Capacity (KG)	Cold Inflation Pressure (KPA)	T/TL
10-16.5	8	-	8.25	15.0	773	264	1880	410	TL
12-16.5	10	-	9.75	18.0	831	307	2540	450	TL



### CL719

Skid Steer

Size	TRA Code	Ply Rating	Standard Rim	Tread Depth (mm)	Overall Diameter (mm)	Section Width (mm)	Max. Load Capacity (KG)	Cold Inflation Pressure (KPA)	T/TL
10-16.5	8	-	8.25	16.0	773	264	1880	410	TL
12-16.5	10	-	9.75	18.0	831	307	2540	450	TL





# CL720

Skid Steer

Size	TRA Code	Ply Rating	Standard Rim	Tread Depth (mm)	Overall Diameter (mm)	Section Width (mm)	Max. Load Capacity (KG)	Cold Inflation Pressure (KPA)	TT/TL
10-16.5	12	-	8.25	25.0	773	264	2375	620	TL



# CL723

Skid Steer

Size	TRA Code	Ply Rating	Standard Rim	Tread Depth (mm)	Overall Diameter (mm)	Section Width (mm)	Max. Load Capacity (KG)	Cold Inflation Pressure (KPA)	TT/TL
10-16.5	10	-	8.25	22.0	773	264	2135	520	TL
12-16.5	12	-	9.75	24.0	831	307	2865	550	TL



# CL721

Skid Steer

Size	TRA Code	Ply Rating	Standard Rim	Tread Depth (mm)	Overall Diameter (mm)	Section Width (mm)	Max. Load Capacity (KG)	Cold Inflation Pressure (KPA)	TT/TL
12-16.5	14	-	9.75	35.0	931	307	3075	620	TL



# K192

Skid Steer

Size	TRA Code	Ply Rating	Standard Rim	Tread Depth (mm)	Overall Diameter (mm)	Section Width (mm)	Max. Load Capacity (KG)	Cold Inflation Pressure (KPA)	TT/TL
10-16.5	8	-	8.25	19.5	773	264	1880	410	TL
	10	-	8.25	19.5	773	264	2135	520	TL
12-16.5	10	-	9.75	22.0	831	307	2540	450	TL





## OFF-THE-ROAD TYRES-BIAS

## OFF-THE-ROAD TYRES-BIAS Port Service



**NEW**

### EL29

Port Service

Size	TRA Code	Ply Rating	Standard Rim	Tread Depth (mm)	Overall Diameter (mm)	Section Width (mm)	Load Capacity at various speed (KG)				Cold Inflation Pressure (KPA)	T/TL
							0KM/H	5KM/H	10KM/H	25KM/H		
14.00-24	IND-3	28	10	30	1370	375	18000	14500	13500	12000	1000	TT/TL
	IND-3	32	10	30	1370	375	18450	14850	13850	12800	1000	TL



**NEW**

### CL627

Port Service

Size	TRA Code	Ply Rating	Standard Rim	Tread Depth (mm)	Overall Diameter (mm)	Section Width (mm)	Load Capacity at various speed (KG)				Cold Inflation Pressure (KPA)	T/TL
							0KM/H	5KM/H	10KM/H	25KM/H		
18.00-25	IND-3	40	13.00/2.5	43.0	1615	510	30600	24600	22900	21200	1140	TL
	IND-3	44	13.00/2.5	43.0	1615	510	32700	26300	24500	-	1260	TL
21.00-25	IND-3	40	15.00/3.5	44.0	1750	575	36380	29311	27290	-	1000	TL



# OFF-THE-ROAD TYRES-BIAS

# OFF-THE-ROAD TYRES-BIAS



## CL629

Port Service

Size	TRA Code	Ply Rating	Standard Rim	Tread Depth (mm)	Overall Diameter (mm)	Section Width (mm)	Load Capacity at various speed (KG)				Cold Inflation Pressure (KPA)	TT/TL
							0KM/H	5KM/H	10KM/H	25KM/H		
12.00-24	IND-4	24	8.5	35	1245	315	12300	10800	9300	7100	1000	TT
	IND-4	24	10.0	50.0	1370	375	13200	12200	11200	8200	1000	TT
14.00-24	IND-4	28	10.0	50.0	1370	375	14200	13200	12200	9000	1000	TT/TL
	IND-4	32	10.0	50.0	1370	375	15000	14000	13000	9800	1000	TT
16.00-25	IND-4	32	11.25/2.0	50.0	1495	430	22500	18100	16900	15600	1050	TT/TL
	IND-4	36	11.25/2.0	50.0	1495	430	24500	19700	18400	17000	1170	TL
18.00-25	IND-4	40	13.00/2.5	55.0	1673	515	30600	24600	22900	21200	1000	TL



## CL629A

Port Service

Size	TRA Code	Ply Rating	Standard Rim	Tread Depth (mm)	Overall Diameter (mm)	Section Width (mm)	Load Capacity at various speed (KG)				Cold Inflation Pressure (KPA)	TT/TL
							0KM/H	5KM/H	10KM/H	25KM/H		
12.00-24	IND-4	24	8.5	40	1245	315	12300	10800	9300	7100	1000	TT
14.00-24	IND-4	28	10.0	50	1370	375	14200	13200	12200	9000	1150	TT
18.00-25	IND-4	40	13.00/2.5	70.0	1670	515	30600	24600	22900	21200	1000	TL



**NEW**

## EL27

Port Service

Size	TRA Code	Ply Rating	Standard Rim	Tread Depth (mm)	Overall Diameter (mm)	Section Width (mm)	Load Capacity at various speed (KG)				Cold Inflation Pressure (KPA)	TT/TL
							0KM/H	5KM/H	10KM/H	25KM/H		
16.00-25	IND-3	32	11.25/2.0	32.0	1495	430	22500	18100	16900	15600	1000	TL
	IND-3	36	11.25/2.0	32.0	1495	430	24500	19700	18400	17000	1000	TL
18.00-25	IND-3	40	13.00/2.5	43.0	1610	510	30600	24600	22900	-	1140	TL
	IND-3	44	13.00/2.5	43.0	1610	510	32700	26300	24500	-	1260	TL
21.00-25	IND-3	48	13.00/2.5	43.0	1610	510	-	27600	-	-	1260	TL
	IND-3	40	15.00/3.5	38.0	1750	575	36400	29300	27300	-	1000	TL
21.00-35	IND-3	40	15.00/3.0	38.0	2005	570	43735	35230	32800	30370	1000	TL



**NEW**

## EL57

Port Service

Size	TRA Code	Ply Rating	Standard Rim	Tread Depth (mm)	Overall Diameter (mm)	Section Width (mm)	Load Capacity at various speed (KG)				Cold Inflation Pressure (KPA)	TT/TL
							0KM/H	5KM/H	10KM/H	25KM/H		
12.00-24	IND-4	24	8.5	43.5	1245	315	12300	10800	9300	7100	1000	TT



## CL991

Dump Truck

Size	TRA Code	Ply Rating	Standard Rim	Tread Depth (mm)	Overall Diameter (mm)	Section Width (mm)	Max. Load Capacity (KG)	Cold Inflation Pressure (KPA)	TT/TL
E-3	18	8.0	28.0	1105	293	5535	900	TT	
12.00-20	E-3	18	8.5	28.0	1145	315	5915	800	TT
	E-3	20	8.5	28.0	1145	315	6335	900	TT



# OFF-THE-ROAD TYRES-BIAS



**NEW**

## SM05

Port Service

Size	TRA Code	Ply Rating	Standard Rim	Tread Depth (mm)	Overall Diameter (mm)	Section Width (mm)	Load Capacity at various speed (KG)				Cold Inflation Pressure (KPA)	TT/TL
							0KM/H	5KM/H	10KM/H	25KM/H		
18.00-25	IND-5	40	13.00/2.5	90.0	1675	500	30600	24600	22900	21200	1000	TL



## EL39

Port Service

Size	TRA Code	Ply Rating	Standard Rim	Tread Depth (mm)	Overall Diameter (mm)	Section Width (mm)	Max. Load Capacity (KG)	Cold Inflation Pressure (KPA)	TT/TL
11.00-20	E-3	16	8.0	28.0	1105	293	5165	800	TT
	E-3	18	8.0	28.0	1105	293	5535	900	TT
12.00-20	E-3	18	8.5	28.0	1145	315	5915	800	TT
	E-3	20	8.5	28.0	1145	315	6335	900	TT



# OFF-THE-ROAD TYRES-BIAS Industrial Service-Forklift



# OFF-THE-ROAD TYRES-BIAS

# OFF-THE-ROAD TYRES-BIAS



## CL618

Industrial Service-Forklift

Size	TRA Code	Ply Rating	Service Index	Standard Rim	Tread Depth (mm)	Overall Diameter (mm)	Section Width (mm)	Max. Load Capacity (KG)	Cold Inflation Pressure (KPA)	TT/TL
4.00-8	-	6	-	3.00D	7.0	415	112	640	720	TT
7.00-9	-	10	-	5.00S	10.0	590	190	1995	860	TT
8.25-12	-	12	-	5.00S	13.0	728	210	2000	700	TT



## CL619

Industrial Service-Forklift

Size	TRA Code	Ply Rating	Service Index	Standard Rim	Tread Depth (mm)	Overall Diameter (mm)	Section Width (mm)	Max. Load Capacity (KG)	Cold Inflation Pressure (KPA)	TT/TL
5.00-8	-	10	-	3.50D	12.0	470	137	1150	1000	TT
6.00-9	-	8	-	4.00E	13.0	540	160	1315	690	TT
6.00-9	-	10	-	4.00E	13.0	540	160	1505	860	TT
6.50-10	-	10	-	5.00F	13.0	590	175	1655	790	TT
7.00-12	-	12	-	5.00S	15.0	676	190	2375	860	TT
7.00-15	-	12	-	5.5	15.0	750	200	2870	860	TT
7.50-15	-	12	-	6.0	17.0	780	215	3075	790	TT
8.25-15	-	14	-	6.5	16.0	840	235	3775	830	TT
8.25-15	-	16	-	6.5	16.0	840	235	4330	900	TT
18x7-8	-	16	-	4.33R	14.0	173	465	1640	1000	TT
21x8-9	-	14	-	6.00E	15.5	535	200	2040	1000	TT
23x9-10	-	18	-	6.50F	16.0	595	225	3160	1050	TT
28x9-15	-	14	-	7.0	13.0	710	220	3050	970	TT
28x9-15	-	16	-	7.0	13.0	710	220	3115	1000	TT
250-15	-	16	-	7.5	21.5	735	250	3865	930	TT
300-15	-	18	-	8.0	22.0	840	300	5530	830	TT
300-15	-	20	-	8.0	22.0	840	300	5940	930	TT



## CL621

Industrial Service-Forklift

Size	TRA Code	Ply Rating	Service Index	Standard Rim	Tread Depth (mm)	Overall Diameter (mm)	Section Width (mm)	Max. Load Capacity (KG)	Cold Inflation Pressure (KPA)	TT/TL
5.00-8	-	10	-	3.50D	11.0	470	137	1150	1000	TT
6.00-9	-	10	-	4.00E	12.5	540	160	1505	860	TT
7.00-9	-	10	-	5.00S	10.0	590	190	1995	860	TT
6.50-10	-	10	-	5.00F	12.0	590	175	1655	790	TT
7.00-12	-	12	-	5.00S	13.0	676	190	2375	860	TT
8.25-12	-	12	-	6.5	19.0	765	235	3060	720	TT
6.00-15	-	10+	-	4.50E	14.0	705	170	2185	830	TT
8.25-15	-	14	-	6.5	16.0	840	235	3775	830	TT
9.00-16	-	14	-	6.50H	16.0	890	255	4495	760	TT
8.25-20	-	14	-	6.5	15.0	974	235	3865	830	TT
9.00-20	-	16	-	7.0	17	1018	259	4715	860	TT
18x7-8	-	14	-	4.33R	16.0	173	465	1440	900	TT
23x9-10	-	18	-	6.50F	14.0	595	225	3160	1050	TT
27x10-12	-	14	-	8.00G	14.0	690	255	3210	720	TT
28x9-15	-	14	-	7.0	16.0	710	220	3050	970	TT
250-15	-	16	-	7.5	21.0	735	250	3865	930	TT
300-15	-	18+	-	8.0	23.0	840	300	5530	830	TT



## CL628

Industrial Service-Forklift

Size	TRA Code	Ply Rating	Service Index	Standard Rim	Tread Depth (mm)	Overall Diameter (mm)	Section Width (mm)	Max. Load Capacity (KG)	Cold Inflation Pressure (KPA)	TT/TL
6.00-9(B)	-	10	-	4.00E	13.0	540	160	1505	860	TT
6.50-10(B)	-	10	-	5.00F	15.0	590	175	1655	790	TT
7.00-12(B)	-	12	-	5.00S	17.0	676	190	2375	860	TT
8.25-12(B)	-	12	-	6.5	16.5	765	235	3060	720	TT
8.25-15(B)	-	14	-	6.5	15.5	840	235	3775	830	TT
28x9-15(B)	-	14	-	7.0	16.0	710	220	3050	970	TT
300-15(B)	-	18+	-	8.0	23.0	840	300	5530	830	TT





# CL622

Industrial Service-Forklift

Size	TRA Code	Ply Rating	Service Index	Standard Rim	Tread Depth (mm)	Overall Diameter (mm)	Section Width (mm)	Max. Load Capacity (KG)	Cold Inflation Pressure (KPA)	TT/TL
10.00-20	-	16	-	7.5	22.0	1073	278	-	800	TT
12.00-20	-	16	-	8.5	25.0	1145	315	-	700	TT
	-	18	-	8.5	25.0	1145	315	-	700	TT



# CL626

Industrial Service-Forklift

Size	TRA Code	Ply Rating	Service Index	Standard Rim	Tread Depth (mm)	Overall Diameter (mm)	Section Width (mm)	Max. Load Capacity (KG)	Cold Inflation Pressure (KPA)	TT/TL
10.00-20	-	18	-	7.5	26.5	1099	278	6755	910	TT
12.00-20	-	20	-	8.5	26.5	1173	315	8055	880	TT



# CL623

Industrial Service-Forklift

Size	TRA Code	Ply Rating	Service Index	Standard Rim	Tread Depth (mm)	Overall Diameter (mm)	Section Width (mm)	Max. Load Capacity (KG)	Cold Inflation Pressure (KPA)	TT/TL
9.00-16	-	14	-	6.50H	15.0	890	255	4495	760	TT



# EDT

Industrial Service-Forklift

Size	TRA Code	Ply Rating	Service Index	Standard Rim	Tread Depth (mm)	Overall Diameter (mm)	Section Width (mm)	Max. Load Capacity (KG)	Cold Inflation Pressure (KPA)	TT/TL
5.00-8	-	10	-	3.50D	17.5	470	137	1150	1000	TT
6.00-9	-	12	-	4.00E	19.3	540	160	1675	1030	TT
6.50-10	-	12	-	5.00F	23.8	590	175	1860	790	TT
7.00-12	-	14	-	5.00S	22.0	676	190	2590	1000	TT
7.00-15	-	14	-	5.5	23.0	750	200	3140	1000	TT
7.50-15	-	14	-	6.0	21.5	780	215	3375	925	TT
8.25-15	-	14	-	6.5	24.5	840	235	3775	830	TT
28x9-15	-	14	-	7.0	20.6	710	220	3050	970	TT





OFF-THE-ROAD TYRES-SOLID

OFF-THE-ROAD TYRES-SOLID  
Resilent



# CL402(S)

Resilent

Size	Tread Depth (mm)	Standard Rim	Overall Diameter (mm)	Section Width (mm)	Max. Load (Kg/LBS)										Tire Weight (KG)
					6mph/10km/h		10mph/16km/h		15mph/25km/h		Other Vehicles				
					Load	Steer	Load	Steer	Load	Steer	0mph/0mph	4mph/6km/h	6mph/10km/h	15mph/25km/h	
5.00-8	25	3.00D	460	128	1255	965	1145	880	1060	815	1305	1060	960	815	17.7
	25	3.25I	460	128	1360	1045	1235	950	1150	885	1415	1150	1045	885	18.0
6.00-9	25	3.75	460	128	1570	1205	1430	1100	1325	1020	1630	1325	1200	1020	18.1
	25	4.00E	523	146	1975	1520	1805	1390	1675	1290	2065	1675	1520	1290	26.5
6.50-10	25	5.00F	574	156	2715	2090	2485	1910	2310	1775	2840	2310	2095	1775	33.6
	25	5.50F	574	156	2985	2300	2735	2100	2540	1950	3125	2540	2305	1950	34.0
7.00-12	25	5.00S	655	160	3105	2390	2835	2180	2635	2025	3240	2635	2390	2025	45.5
	25	5.50	730	180	3700	2845	3375	2595	3135	2410	3855	3135	2845	2410	57.0
7.00-15	25	6.00	730	180	4035	3105	3680	2830	3420	2630	4205	3420	3105	2630	58.0
	30	5.50	820	207	4305	3310	3925	3020	3640	2800	4480	3640	3305	2800	86.5
8.25-15	30	6.50	820	207	5085	3910	4640	3570	4310	3315	5304	4310	3910	3315	87.0



# OFF-THE-ROAD TYRES-SOLID

# OFF-THE-ROAD TYRES-SOLID



## CL403(S)

Resilent

Size	Tread Depth (mm)	Standard Rim	Overall Diameter (mm)	Section Width (mm)	Max. Load (Kg/LBS)										Tire Weight (Kg)
					6mph/10km/h		10mph/16km/h		15mph/25km/h		Other Vehicles				
					Load	Steer	Load	Steer	Load	Steer	0mph/0mph	4mph/6km/h	6mph/10km/h	15mph/25km/h	
4.00-8	20	3.00D	405	105	1090	840	995	765	925	710	1135	925	840	710	12.5
5.00-8	20	3.75	405	105	1175	905	1080	830	1000	770	1230	1000	910	770	12.5
15x4-12-8(125/75-8)	20	3.00D	380	104	1005	775	915	705	850	655	1050	850	775	655	9.5
16x6-8(150/75-8)	20	3.25I	380	104	1090	840	995	765	925	710	1135	925	835	710	9.5
18x7-8(180/70-8)	20	4.33R	406	146	1545	1190	1410	1085	1305	1005	1610	1305	1185	1005	15.5
6.00-9	25	4.33R	455	158	2430	1870	2215	1705	2060	1585	2535	2060	1870	1585	22.0
7.00-9	25	4.00E	525	146	1975	1520	1805	1390	1675	1290	2065	1675	1520	1290	26.5
21x8-9(200/75-9)	30	5.00S	550	168	2670	2055	2440	1875	2260	1740	2785	2260	2055	1740	35.0
6.50-10	25	6.00E	518	182	2890	2225	2645	2035	2455	1890	3025	2455	2230	1890	33.0
200/50-10	25	5.00F	570	156	2715	2090	2485	1910	2310	1775	2840	2310	2095	1775	33.8
23x9-10(225/75-10)	20	6.50F	457	196	2910	2240	2665	2050	2470	1900	3040	2470	2240	1900	25.0
7.00-12	30	6.50F	580	200	3730	2870	3405	2620	3160	2430	3890	3160	2865	2430	46.0
8.25-12	30	5.00S	654	170	3105	2390	2835	2180	2635	2025	3240	2635	2390	2025	46.5
23x10-12(250/60-12)	30	6.50	660	229	3926	3020	3590	2760	3330	2560	3840	3330	3020	2560	63.3
27x10-12(250/75-12)	35	5.00S	720	195	3425	2635	3125	2405	2905	2235	3575	2905	2635	2235	64.2
250-15(250/70-15)	25	8.00G	585	240	4450	3425	4060	3125	3770	2900	4640	3770	3420	2900	51.8
300-15(315/70-15)	30	8.00G	676	240	4595	3535	4200	3230	3900	3000	4800	3900	3540	3000	72.0
7.50-15	30	7.00	720	236	5220	4015	4770	3670	4425	3405	5450	4425	4015	3405	73.0
8.25-15	30	7.50	720	236	5595	4305	5110	3930	4745	3650	5840	4745	4305	3650	73.5
28x9-15(225/75-15)(8.15-15)	30	8.00	813	254	6895	5305	6300	4845	5850	4500	7200	5850	5310	4500	108.0
7.50-15	30	5.50	750	190	3805	2925	3470	2670	3225	2480	3970	3225	2925	2480	68.0
8.25-15	30	6.50	750	190	4490	3455	4100	3155	3810	2930	4690	3810	3455	2930	69.0
28x12.5-15(315/50-15)	35	5.50	818	203	4305	3310	3925	3020	3640	2800	4480	3640	3305	2800	88.5
32x12.1-15(355/65-15)	35	6.50	818	203	5085	3910	4640	3570	4310	3315	5304	4310	3910	3315	88.5
6.50-16	25	6.50	700	215	3770	2900	3445	2650	3200	2460	3935	3200	2900	2460	60.9
7.50-16	25	7.00	700	215	4060	3125	3710	2855	3445	2650	4240	3445	3125	2650	60.9
8.00-16	30	9.75	706	300	6200	4770	5660	4355	5260	4045	6470	5260	4775	4045	88.8
9.00-16	30	9.75	808	290	-	-	-	-	7800	6000	9600	7085	6430	5450	123.0
7.50-16	30	5.50	742	173	3545	2725	3235	2490	3005	2310	3695	3005	2725	2310	57.6
8.00-16	30	5.50F	814	190	4035	3105	3685	2835	3425	2635	4215	3425	3110	2635	78
9.00-16	30	6.00G	814	190	4400	3385	4025	3095	3730	2870	4590	3730	3385	2870	78.8
8.25-20	45	5.50F	820	205	4070	3130	3720	2860	3450	2655	4250	3450	3135	2655	86.5
9.00-20	45	7.00	960	220	5165	4305	4715	3930	4380	3650	5475	4745	3980	3650	123.0
10.00-20	45	7.00	960	220	5335	4445	4870	4060	4525	3770	5655	4900	4110	3770	123.6
11.00-20	45	6.50	1010	246	6160	5135	5630	4690	5225	4355	6535	5660	4745	4355	149.0
12.00-20	45	7.00	1010	246	6365	5305	5815	4845	5400	4500	6750	5850	4905	4500	151.0
13.00-20	45	7.00	1010	246	6845	5705	6260	5215	5815	4845	7270	5815	5280	4845	151.0
14.00-20	45	7.50	1010	246	7075	5895	6460	5385	6000	5000	7500	6500	5450	5000	153.0
15.00-20	45	8.00	1010	246	7300	6085	6670	5560	6200	5165	7750	6715	5630	5165	155.0
16.00-20	45	8.00	1085	280	7715	6430	7045	5870	6540	5450	8175	7085	5940	5450	218.0
17.00-20	45	8.00	1088	260	8640	7200	7885	6570	7320	6100	9150	7930	6650	6100	195.0
18.00-20	45	8.50	1088	260	8920	7435	8140	6785	7560	6300	9450	8190	6865	6300	197.0
19.00-20	45	10.00W	1278	362	11630	9690	10620	8850	9860	8215	12320	9860	8955	8215	408.0
20.00-24	35	10.00	1300	324	12165	10135	11105	9255	10315	8595	12890	11175	9370	8595	354.0



## CL404(S)

Resilent

Size	Tread Depth (mm)	Standard Rim	Overall Diameter (mm)	Section Width (mm)	Max. Load (Kg/LBS)										Tire Weight (Kg)
					6mph/10km/h		10mph/16km/h		15mph/25km/h		Other Vehicles				
					Load	Steer	Load	Steer	Load	Steer	0mph/0mph	4mph/6km/h	6mph/10km/h	15mph/25km/h	
9.00-16	25	6.50H	860	230	5290	4070	4830	3715	4485	3450	5520	4485	4070	3450	112.0
10.00-20	25	7.00N	860	230	5695	4385	5200	4000	4830	3715	5945	4830	4385	3715	112.0
11.00-20	25	7.00	1042	260	6845	5705	6260	5215	5815	4845	7270	5815	5280	4845	184.0
12.00-20	25	7.50	1042	260	7075	5895	6460	5385	6000	5000	7500	6500	5450	5000	185.0
13.00-20	25	8.00	1042	260	7300	6085	6670	5560	6200	5165	7750	6715	5630	5165	186.0
14.00-20	25	8.00	1120	290	8640	7200	7885	6570	7320	6100	9150	7930	6650	6100	241.0
15.00-20	25	8.50	1120	290	8920	7435	8140	6785	7560	6300	9450	8190	6865	6300	242.0
16.00-24	30	8.50	1216	306	9125	7605	8335	6945	7740	6450	9675	8385	7030	6450	283.6



## CL406(S)

Resilent

Size	Tread Depth (mm)	Standard Rim	Overall Diameter (mm)	Section Width (mm)	Max. Load (Kg/LBS)										Tire Weight (Kg)				
					6mph/10km/h		10mph/16km/h		15mph/25km/h		Other Vehicles								
					Load	Steer	Load	Steer	Load	Steer	0mph/0mph	4mph/6km/h	6mph/10km/h	15mph/25km/h					
30x10-20	33	7.50	762	254	-	-	-	-	-	-	-	-	-	-	-	71.3			
33x10.75-20	33	7.50	832	272	-	-	-	-	-	-	-	-	-	-	4425	3835	3215	2950	99.5



# OFF-THE-ROAD TYRES-SOLID

# OFF-THE-ROAD TYRES-SOLID



## GHT01(S)

Resilent

Size	Tread Depth (mm)	Standard Rim	Overall Diameter (mm)	Section Width (mm)	Max. Load (Kg/LBS)										Tire Weight (KG)
					6mph/10km/h		10mph/16km/h		15mph/25km/h		Other Vehicles				
					Load	Steer	Load	Steer	Load	Steer	0mph/0mph	4mph/6km/h	6mph/10km/h	15mph/25km/h	
3.50-5	13	3.00	298	102	760	610	735	550	685	515	770	670	605	515	6.0
5.00-8	18	3.00D	450	130	1255	965	1145	880	1060	815	1305	1060	960	815	17.0
16x6-8(150/75-8)	15	4.33R	412	152	1545	1190	1410	1085	1305	1005	1610	1305	1185	1005	16.0
18x7-8(180/70-8)	18	4.33R	456	162	2430	1870	2215	1705	2060	1585	2535	2060	1870	1585	22.0
6.00-9	18	4.00E	525	150	1975	1520	1805	1390	1675	1290	2065	1675	1520	1290	26.8
7.00-9	20	5.00S	550	168	2670	2055	2440	1875	2260	1740	2785	2260	2055	1740	34.0
21x8-9(200/75-9)	18	6.00E	518	182	2890	2225	2645	2035	2455	1890	3025	2455	2230	1890	34.4
6.50-10	18	5.00F	570	160	2715	2090	2485	1910	2310	1775	2840	2310	2095	1775	34.5
23x9-10(225/75-10)	25	6.50F	580	210	3730	2870	3405	2620	3160	2430	3890	3160	2865	2430	46.6
7.00-12	18	5.00S	654	170	3105	2390	2835	2180	2635	2025	3240	2635	2390	2025	46.5
8.25-12	25	5.00S	720	190	3425	2635	3125	2405	2905	2235	3575	2905	2635	2235	65.0
5.50-15	22	4.50E	672	150	2525	1870	2415	1790	2195	1625	2435	2110	1715	1625	38.8
6.00-15	22	4.50E	710	164	2830	2095	2705	2000	2455	1820	2730	2365	2145	1820	48.2
7.00-15	25	5.50	736	194	3700	2845	3375	2595	3135	2410	3855	3135	2845	2410	64.5
8.25-15	25	5.50	820	212	4305	3310	3925	3020	3640	2800	4480	3640	3305	2800	92.0
28x9-15(225/75-15)	20	6.50	700	215	3770	2900	3445	2650	3200	2460	3935	3200	2900	2460	63.0
300-15(315/70-15)	25	8.00	813	256	6895	5305	6300	4845	5850	4500	7200	5850	5310	4500	108.4
8.25-20	30	6.50	960	220	5165	4305	4715	3930	4380	3650	5475	4745	3980	3650	123.0
9.00-20	30	7.00	960	220	5335	4445	4870	4060	4525	3770	5655	4900	4110	3770	123.8
9.00-20	30	6.50	1010	235	6160	5135	5630	4690	5225	4355	6535	5660	4745	4355	147.5
9.00-20	30	7.00	1010	235	6365	5305	5815	4845	5400	4500	6750	5850	4905	4500	148.2



## GHT01H

Resilent

Size	Tread Depth (mm)	Standard Rim	Overall Diameter (mm)	Section Width (mm)	Max. Load (Kg/LBS)										Tire Weight (KG)
					6mph/10km/h		10mph/16km/h		15mph/25km/h		Other Vehicles				
					Load	Steer	Load	Steer	Load	Steer	0mph/0mph	4mph/6km/h	6mph/10km/h	15mph/25km/h	
6.00-9	18	4.00E	525	150	1975	1520	1805	1390	1675	1290	2065	1675	1520	1290	25.0
6.50-10	18	5.00F	570	160	2715	2090	2485	1910	2310	1775	2840	2310	2095	1775	33.0
7.00-12	18	5.00S	654	170	3105	2390	2835	2180	2635	2025	3240	2635	2390	2025	45.0
250-15(250/70-15)	20	7.00	720	236	5220	4015	4770	3670	4425	3405	5450	4425	4015	3405	73.0
300-15(315/70-15)	20	7.50	720	236	5595	4305	5110	3930	4745	3650	5840	4745	4305	3650	73.5
7.00-15	25	5.50	736	194	3700	2845	3375	2595	3135	2410	3855	3135	2845	2410	61.0
8.25-15	25	5.50	820	212	4305	3310	3925	3020	3640	2800	4480	3640	3305	2800	89.0
28x9-15	20	6.50	700	215	3770	2900	3445	2650	3200	2460	3935	3200	2900	2460	60.7
300-15(315/70-15)	20	7.00	700	215	4060	3125	3710	2855	3445	2650	4240	3445	3125	2650	61.0



## RIB01(S)

Resilent

Size	Tread Depth (mm)	Standard Rim	Overall Diameter (mm)	Section Width (mm)	Max. Load (Kg/LBS)										Tire Weight (KG)
					6mph/10km/h		10mph/16km/h		15mph/25km/h		Other Vehicles				
					Load	Steer	Load	Steer	Load	Steer	0mph/0mph	4mph/6km/h	6mph/10km/h	15mph/25km/h	
3.20-8	2	3.00D	325	110	760	585	695	535	645	495	740	645	585	495	6.4
4.00-8	4	3.00D	405	105	1090	840	995	765	925	710	1135	925	840	710	12.5
15x4 1/2-8	4	3.75	405	105	1175	905	1080	830	1000	770	1230	1000	910	770	12.5
40x14-16	4	3.00D	380	104	1005	775	915	705	850	655	1050	850	775	655	9.5
40x14-16	4	3.25I	380	104	1090	840	995	765	925	710	1135	925	835	710	9.5
40x14-16	8	11	1006	356	-	-	-	-	-	-	10635	9215	8365	7090	256.5



# OFF-THE-ROAD TYRES-SOLID



## SM Resilent

Size	Tread Depth (mm)	Standard Rim	Overall Diameter (mm)	Section Width (mm)	Max. Load (Kg/LBS)										Tire Weight (KG)
					6mph/10km/h		10mph/16km/h		15mph/25km/h		Other Vehicles				
					Load	Steer	Load	Steer	Load	Steer	0mph/0mph	4mph/6km/h	6mph/10km/h	15mph/25km/h	
10.00-20	-	7.50	1020	240	7075	5895	6460	5385	6000	5000	7500	6500	5450	5000	170.8



# OFF-THE-ROAD TYRES-BIAS Press On



# OFF-THE-ROAD TYRES-SOLID

# OFF-THE-ROAD TYRES-SOLID



## SM/TR

Press On

Size	Overall Diameter (mm)	Section Width (mm)	Max. Load (Kg/LBS)					Weight (Kg/LBS)	
			6mph/10km/h		10mph/16km/h		Other Vehicles 10mph/16km/h	SM	TR
			Load	Steer	Load	Steer			
9x5x5	229	127	890	790	785	715	685	6.2	-
10x4 3/4x6 1/2	254	121	885	790	785	710	680	6.7	-
10x5x6 1/2	254	127	940	835	830	755	725	7.0	6.9
10 1/2x5x6 1/2	267	127	1000	890	885	805	770	7.8	-
12x4x8	305	102	835	745	740	670	645	7.4	-
12x4 1/2x8	305	114	970	865	860	780	745	8.4	-
12x5 1/2x8	305	140	1240	1100	1095	995	950	10.3	-
13 1/2x5 1/2x8	343	140	1400	1245	1235	1125	1075	13.4	12.3
14x4 1/2x8	356	114	1085	965	960	870	835	11.2	10.7
14x5x10	356	127	1240	1100	1095	995	955	11.5	-
15x4x11 1/4	381	102	985	875	870	790	755	10.2	-
15x5x11 1/4	381	127	1290	1150	1145	1040	995	12.1	-
16x5x10 1/2	406	127	1400	1245	1240	1125	1075	14.5	14.3
16x6x10 1/2	406	152	1775	1580	1570	1430	1365	17.6	17.1
16x7x10 1/2	406	178	2155	1915	1905	1730	1655	20.8	-
16 1/4x5x11 1/4	413	127	1415	1260	1250	1135	1090	14.5	14.1
16 1/4x6x11 1/4	413	152	1780	1585	1575	1430	1370	17.5	16.9
16 1/4x7x11 1/4	413	178	2150	1915	1900	1730	1655	20.8	20.0
17x5x12 1/8	432	127	1460	1300	1295	1175	1125	15.3	-
18x5x12 1/8	457	127	1525	1355	1350	1225	1175	17.5	16.8
18x6x12 1/8	457	152	1945	1735	1720	1565	1500	21.2	20.3
18x7x12 1/8	457	178	2370	2110	2095	1905	1820	24.4	23.9
18x8x12 1/8	457	203	2790	2485	2470	2245	2145	28.3	26.9
18x9x12 1/8	457	229	3215	2860	2840	2580	2470	34.0	34.0
21x6x15	533	152	2185	1945	1935	1760	1680	25.7	25.3
21x7x15	533	178	2665	2370	2355	2140	2050	30.0	29.3
21x8x15	533	203	3140	2795	2780	2525	2415	34.5	33.0
21x9x15	533	229	3620	3220	3200	2910	2785	39.4	-
20x5x16	508	127	1620	1440	1430	1300	1245	17.9	-
20x8x16	508	203	2795	2490	2475	2250	2150	28.8	27.6
22x8x16	559	203	3255	2895	2880	2615	2500	36.8	35.0
22x9x16	559	229	3745	3335	3315	3010	2880	45.1	42.9
22x10x16	559	254	4240	3775	3750	3410	3265	51.0	-
22x12x16	559	305	5230	4655	4625	4205	4025	61.3	60.3
22x14x16	559	356	6220	5535	5500	5000	4785	73.0	-
22x16x16	559	406	7205	6415	6375	5795	5545	83.0	-
28x12x22	711	305	6265	5575	5545	5035	4820	81.4	-
660x203x480	660	203	3740	3330	3310	3010	2880	54.5	-



## SM/TR

Press On

Size	Overall Diameter (mm)	Section Width (mm)	Max. Load (Kg/LBS)					Weight (Kg/LBS)	
			6mph/10km/h		10mph/16km/h		Other Vehicles 10mph/16km/h	SM	TR
			Load	Steer	Load	Steer			
9x5x5	229	127	890	790	785	715	685	6.4	-
10x4 3/4x6 1/2	254	121	885	790	785	710	680	7.0	-
10x5x6 1/2	254	127	940	835	830	755	725	7.2	7.5
10 1/2x5x6 1/2	267	127	1000	890	885	805	770	8.0	-
12x4x8	305	102	835	745	740	670	645	7.6	-
12x4 1/2x8	305	114	970	865	860	780	745	8.8	-
12x5 1/2x8	305	140	1240	1100	1095	995	950	10.8	-
13 1/2x5 1/2x8	343	140	1400	1245	1235	1125	1075	14.1	12.6
14x4 1/2x8	356	114	1085	965	960	870	835	11.6	11.2
14x5x10	356	127	1240	1100	1095	995	955	11.9	-
15x4x11 1/4	381	102	985	875	870	790	755	10.5	-
15x5x11 1/4	381	127	1290	1150	1145	1040	995	12.8	-
16x5x10 1/2	406	127	1400	1245	1240	1125	1075	15.2	14.7
16x6x10 1/2	406	152	1775	1580	1570	1430	1365	18.3	17.7
16x7x10 1/2	406	178	2155	1915	1905	1730	1655	21.4	-
16 1/4x5x11 1/4	413	127	1415	1260	1250	1135	1090	15.1	14.5
16 1/4x6x11 1/4	413	152	1780	1585	1575	1430	1370	18.1	17.4
16 1/4x7x11 1/4	413	178	2150	1915	1900	1730	1655	21.4	20.6
17x5x12 1/8	432	127	1460	1300	1295	1175	1125	15.7	-
18x5x12 1/8	457	127	1525	1355	1350	1225	1175	18.2	17.5
18x6x12 1/8	457	152	1945	1735	1720	1565	1500	22.1	21.0
18x7x12 1/8	457	178	2370	2110	2095	1905	1820	25.2	24.9
18x8x12 1/8	457	203	2790	2485	2470	2245	2145	29.0	28.3
18x9x12 1/8	457	229	3215	2860	2840	2580	2470	35.0	35.0
21x6x15	533	152	2185	1945	1935	1760	1680	26.6	26.1
21x7x15	533	178	2665	2370	2355	2140	2050	31.1	30.0
21x8x15	533	203	3140	2795	2780	2525	2415	35.7	34.0
21x9x15	533	229	3620	3220	3200	2910	2785	40.3	-
20x5x16	508	127	1620	1440	1430	1300	1245	18.5	-
20x8x16	508	203	2795	2490	2475	2250	2150	29.4	28.5
22x8x16	559	203	3255	2895	2880	2615	2500	37.7	36.0
22x9x16	559	229	3745	3335	3315	3010	2880	46.6	44.1
22x10x16	559	254	4240	3775	3750	3410	3265	63.2	62.0
28x12x22	711	305	6265	5575	5545	5035	4820	83.5	-



# Load & Inflation Pressure Table

## Off -The-Road Slow Speed Service for Loader & Dozers

### Wide Base Radial Ply Tyres

Tyre Size Designation	Air Pressure (kPa)													
	kPa	300	325	350	375	400	425	450	475	500	525	550	575	600
	psi	44	47	51	54	58	62	65	69	73	76	80	83	87
20.5R25 ★	kg	4800	5100	5400	5700	6000	6250	6550	6800	7050	7300	7600	7850	8100
23.5R25 ★		6100	6500	6850	7200	7550	7900	8250	8600	8950	9250	9600	9950	10250
26.5R25 ★		7600	8050	8500	8950	9400	9850	10250	10700	11100	11500	11950	12350	12750
29.5R25 ★		9250	9800	10350	10900	11450	11950	12500	13000	13500	14000	14500	15000	15500

It is permissible to increase inflation pressure up to 100kPa(15psi) above table without increase in load.

Operating Speed (km/h)	Variation in Load Capacity(%)
Static	+60
Creep	+30
4km/h (2.5mph)	+15
10km/h (5mph)	0
15km/h (10mph)	-13
25km/h (15mph)	-20

### Load & Carry operation of front end loaders

Maximum Haul Length	Maximum speed	Maximum load
3610m (2000ft)	25km/h (15mph)	Standard load × 0.8
4244m (800ft)	25km/h (15mph)	Standard load × 0.8
576m (250ft)	10km/h (5mph)	Standard load × 1.0

**Note:** When tires are used on for dig and load vehicles in load and carry operations, the haul distance must be limited to 75 meters and maximum speed to 10km/h.

## Off -The-Road Haulage Service for Dump Trucks & Scraper

### Wide Base Radial Ply Tyres

Tyre Size Designation	Air Pressure (kPa)													
	kPa	300	325	350	375	400	425	450	475	500	525	550	575	600
	psi	44	47	51	54	58	62	65	69	73	76	80	83	87
20.5R25 ★★	kg	4800	5100	5400	5700	6000	6250	6550	6800	7050	7300	7600	7850	8100
23.5R25 ★★		6100	6500	6850	7200	7550	7900	8250	8600	8950	9250	9600	9950	10250
26.5R25 ★★		7600	8050	8500	8950	9400	9850	10250	10700	11100	11500	11950	12350	12750
29.5R25 ★★		9250	9800	10350	10900	11450	11950	12500	13000	13500	14000	14500	15000	15500

### Narrow Base Radial Ply Tyres

Tyre Size Designation	Air Pressure (kPa)													
	kPa	450	475	500	525	550	575	600	650	675	700	725	750	775
	psi	65	69	73	76	80	83	87	91	94	98	105	109	112
14.00R25★★★	kg	3850	4050	4300	4550	4750	4950	5200	5400	5600	5800	6050	6250	6450
21.00R35★★		9550	10150	10700	11300	11850	12400	12950	13500	14000	14500	15050	15550	16050
24.00R35★★		12200	12950	13650	14400	15100	15800	16500	17200	17850	18500	19200	19900	20500

Operating Speed (km/h)	Variation in Load Capacity(%)
15km/h 9.3mph	+12
20km/h 12.4mph	+10
25km/h 15.5mph	+8
30km/h 18.6mph	+6
35km/h 21.7mph	+4
40km/h 24.8mph	+3
45km/h 27.9mph	+2
50km/h 31.1mph	0
55km/h 34.2mph	-2
60km/h 37.3mph	-6
65km/h 40.4mph	-12
65km/h>	★

★ : Consult ZC Rubber concerned



# Load & Inflation Pressure Table

## Off-The-Road in Highway Service for Mobile Cranes

CB767 20.5R25 (525/80R25) SI/LI=179E Highway Application

Rim: 17.00/2.0

V (km/h)	Air Pressure (kPa)												
	600	625	650	675	700	725	750	775	800	825	875	900	1000
Creap	19900	20450	21050	21600	22200	22900	23500	24050	24600	25200	26350	26900	28900
2	17700	18200	18700	19200	19700	20350	20850	21350	21850	22400	23400	23900	25700
10	13150	13550	13900	14300	14650	15150	15500	15900	16300	16650	17400		
30	9050	9300	9600	9850	10100	10400	10700	10900	11200	11400	12000		
50	8250	8450	8700	8950	9150	9450	9700	9950	10100	10400	10900		
70	6950	7150	7350	7550	7750	8000	8200	8400					
80	5700	5900	6050	6200	6400	6600	6750	6900					

In case of over 50km/h average speed, never continuously run 2 hours due to heat trouble.

## Load capacities at Various speed for Industrial Vehicles

Recommended by ZC rubber For HARD IMPROVED SURFACE

Size	Li/SS	AP	0 km/h	1 km/h	5 km/h	10 km/h	15 km/h	20 km/h	25 km/h
12.00R20	184A1	1000	10,650	10,150	9,350	9,250	8,700	8,050	7,100
		950	10,200	9,800	9,000	8,900	8,350	7,750	6,850
		850	10,000	9,600	8,800	8,700	8,200	7,600	6,700
23.5R25	212A2	800	28,100	25,000	22,600	21,000	20,200	19,900	19,500
		750	26,800	23,800	21,500	20,000	19,300	18,900	18,600
		700	25,400	22,600	20,400	19,000	18,300	18,000	17,600
26.5R25	218A2	750	33,200	29,500	26,700	24,900	24,000	23,400	23,000
		700	31,500	28,000	25,400	23,600	22,700	22,200	21,900
		650	29,800	26,500	24,000	22,300	21,500	21,000	20,700
16.00R25	200A5	1,000	20,200	17,900	16,200	15,100	14,600	14,200	14,000
		950	19,300	17,200	15,600	14,500	14,000	13,600	13,400
		900	18,700	16,700	15,000	14,000	13,500	13,200	13,000
16.00R25	203A5	1,000	22,300	19,800	18,000	16,700	16,100	15,700	15,500
		950	21,500	19,100	17,300	16,100	15,600	15,200	15,000
		900	20,700	18,400	16,700	15,600	15,000	14,600	14,400

- Note:**
- 1 Check maximum air pressure requirements of rims and wheels to ensure ability to accommodate correct air pressure of tyre.
  - 2 To obtain the maximum permissible load on lift truck STEERING WHEEL, the above load by 0.8.
  - 3 For speed exceeding 25 km/h, please consult a ZC rubber.



# Radial OTR Range According To Rim

SIZE	PATTERN	TRA Code	Ply Rating	Service Index	Standard Rim	Tread Depth (mm)	Tread Depth (32ND)	Overall Diameter (mm)	Overall Diameter (inch)	Section Width (mm)	Section Width (inch)	Max. Load Capacity (Kg)	Max. Load Capacity (LBS)	Cold Inflation Pressure (KPA)	Cold Inflation Pressure (PSI)	TT/TL
15.5R25	CB761	L3	★	169A2	12.00/1.3	26.0	33	1275	50.2	395	15.6	5800	12800	500	73	TL
17.5R25	CB760	E3	★★	167B	14.00/1.5	27.0	34	1350	53.1	445	17.5	5450	12000	525	76	TL
	CB760	L3	★	176A2	14.00/1.5	27.0	34	1350	53.1	445	17.5	7100	15700	500	73	TL
20.5R25	CB760	E3	★★	177B	17.00/2.0	28.5	36	1490	58.7	520	20.5	7300	16100	525	76	TL
	CB760	L3	★	186A2	17.00/2.0	28.5	36	1490	58.7	520	20.5	9500	20900	500	73	TL
	CB761	E3	★★	177B	17.00/2.0	33.0	42	1490	58.7	520	20.5	7300	16100	525	76	TL
	CB761	L3	★	186A2	17.00/2.0	33.0	42	1490	58.7	520	20.5	9500	20900	500	73	TL
	CB790	L5	★★	193A2	17.00/2.0	72.0	91	1550	61.0	520	20.5	11500	25400	650	94	TL
23.5R25	CB760	E3	★★	185B	19.50/2.5	35.5	45	1615	63.6	595	23.4	9250	20400	525	76	TL
	CB760	L3	★	195A2	19.50/2.5	35.5	45	1615	63.6	595	23.4	12150	26800	500	73	TL
	CB761	E3	★★	185B	19.50/2.5	36.0	45	1615	63.6	595	23.4	9250	20400	525	76	TL
	CB761	L3	★	195A2	19.50/2.5	36.0	45	1615	63.6	595	23.4	12150	26800	500	73	TL
	CB768	E3	★★	185B	19.50/2.5	44.0	55	1615	63.6	595	23.4	9250	20400	525	76	TL
	CB768	L3	★	195A2	19.50/2.5	44.0	55	1615	63.6	595	23.4	12150	26800	500	73	TL
	CB792	E3+	★★	185B	19.50/2.5	38.0	48	1615	63.6	595	23.4	9250	20400	525	76	TL
	CB792	L3+	★	195A2	19.50/2.5	38.0	48	1615	63.6	595	23.4	12150	26800	500	73	TL
	CB763	E4	★★	185B	19.50/2.5	53.0	67	1615	63.6	595	23.4	9250	20400	525	76	TL
	CB763	L4	★	195A2	19.50/2.5	53.0	67	1615	63.6	595	23.4	12150	26800	500	73	TL
	CB773	L-5	★★	201A2	19.50/2.5	76.0	96	1675	65.9	595	23.4	14500	32000	650	94	TL
CB790	L-5	★★	201A2	19.50/2.5	78.0	98	1675	65.9	595	23.4	14500	32000	650	94	TL	
26.5R25	CB761	E3	★★	193B	22.00/3.0	37.0	47	1750	68.9	675	26.6	11500	25400	525	76	TL
	CB761	L3	★	202A2	22.00/3.0	37.0	47	1750	68.9	675	26.6	15000	33100	500	73	TL
	CB792	E3+	★★	193B	22.00/3.0	40.0	50	1750	68.9	675	26.6	11500	25400	525	76	TL
	CB792	L3+	★	202A2	22.00/3.0	40.0	50	1750	68.9	675	26.6	15000	33100	500	73	TL
	CB763	E4	★★	193B	22.00/3.0	56.0	71	1750	68.9	675	26.6	11500	25400	525	76	TL
	CB763	L4	★	202A2	22.00/3.0	56.0	71	1750	68.9	675	26.6	15000	33100	500	73	TL
	CB773	L-5	★★	209A2	22.00/3.0	86.0	108	1800	70.9	675	26.6	18500	40800	650	94	TL
	CB790	L-5	★★	209A2	22.00/3.0	88.0	111	1800	70.9	675	26.6	18500	40800	650	94	TL
29.5R25	CB761	E3	★★	200B	25.00/3.5	43.0	54	1875	73.8	750	29.5	14000	30900	525	76	TL
	CB761	L3	★	208A2	25.00/3.5	43.0	54	1875	73.8	750	29.5	18000	39700	500	73	TL
	CB792	E3+	★★	200B	25.00/3.5	44.0	55	1875	73.8	750	29.5	14000	30900	525	76	TL
	CB792	L3+	★	208A2	25.00/3.5	44.0	55	1875	73.8	750	29.5	18000	39700	500	73	TL
	CB763	E4	★★	200B	25.00/3.5	59.0	74	1875	73.8	750	29.5	14000	30900	525	76	TL
	CB763	L4	★	208A2	25.00/3.5	59.0	74	1875	73.8	750	29.5	18000	39700	500	73	TL
	CB768	E-4	★★	200B	25.00/3.5	50.0	63	1875	73.8	750	29.5	14000	30900	525	76	TL
	CB768	L-4	★	208A2	25.00/3.5	50.0	63	1875	73.8	750	29.5	18000	39700	500	73	TL
	CB790	L-5	★★	216A2	25.00/3.5	96.0	121	1920	75.6	750	29.5	22400	49400	650	94	TL
CB773	L-5	★★	216A2	25.00/3.5	94.0	118	1920	75.6	750	29.5	22400	49400	650	94	TL	
395/85R20(14.00R20)	CM770	-	20PR	170F	10.00	17.5	22	1180	46.5	386	15.2	6000	13230	900	130	TL
13.00R24	CB776	G-2	★	146A8	8.00TG	25.0	31	1280	50.4	335	13.2	3000	6600	375	54	TL
385/95R24(14.00R24)	CM770	-	★★★	170F	10.00/1.5	24.0	30	1369	53.9	379	14.9	6000	13230	900	131	TT
14.00R24	CB765	E-3	★★★	169B	10.00/1.5	27.0	34	1370	53.9	375	14.8	5800	12800	700	101	TT
	CB776	G-2	★	153A8	8.00TG	26.0	33	1350	53.1	360	14.2	3650	8075	375	54	TL
385/95R25(14.00R25)	CM770	-	★★★	170F	10.00/1.5	24.0	30	1369	53.9	379	14.9	6000	13230	900	131	TL
16.00R24	CB776	G-2	★	161A8	10.00VA	29.0	37	1460	57.5	425	16.7	4625	10200	375	54	TL
13.00R25	CB765	E-3	★★★	163B	10.00/1.5	27.0	34	1300	51.2	350	13.8	4875	10700	700	102	TT
14.00R25	CB771	E-4	★★★	169B	10.00/1.5	38.0	48	1420	55.9	375	14.8	5800	12800	700	101	TT/TL
	CB765	E-3	★★★	169B	10.00/1.5	27.0	34	1370	53.9	375	14.8	5800	12800	700	101	TT
445/95R25(16.00R25)	CM770	-	★★★	174F	11.25/2.0	28	35	1481	58.3	435	17.1	6700	14800	900	131	TL
16.00R25	CR766	STRADDLE	★★	200A5	11.25/2.0	50.0	63	1550	61.0	430	16.9	14000	30870	1000	145	TL
	CR766+	STRADDLE	★★	202A7	11.25/2.0	50.0	63	1550	61.0	430	16.9	15000	33100	1000	145	TL
525/80R25(20.5R25)	CM767	-	★★★	176F	17.00/2.0	28.5	36	1490	58.7	520	20.5	7750	17100	700	102	TL
18.00R33	CB771	E-4	★★	191B	13.00/2.5	54.0	68	1875	73.8	500	19.7	10900	24000	700	102	TL
24.00R35	CB765	E-4	★★	209B	17.00/3.5	57.0	72	2175	85.6	655	25.8	18500	40800	700	102	TL
	CB771	E-4	★★	209B	17.00/3.5	65.0	82	2175	85.6	655	25.8	18500	40820	700	102	TL
27.00R49	CB775	E-4	★★	223B	19.50/4.0	63.0	79	2700	106.3	735	28.9	27250	60000	700	102	TL
	CB791	E-4	★★	223B	19.50/4.0	72.0	91	2700	106.3	735	28.9	27250	60000	700	102	TL



